

TECE

NEWS

2026

Mineral cast shower surfaces
Even more design freedom in the bathroom

TECEDrainway shower channel
From the idea to the finished product

TECEDrainline shower channel
Seamless aesthetics

TECESquare toilet flush plate
Harmonious in every aspect

TECEloft Perfect Fit
Added value in the system

close to you

2



1



6



3

4

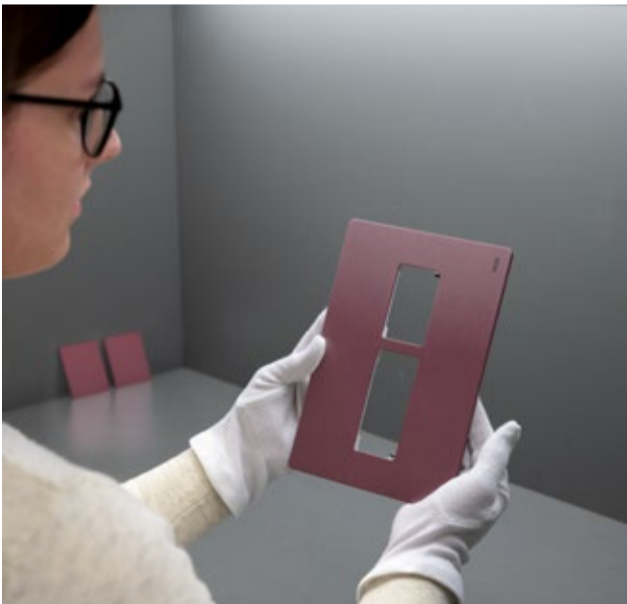

5

- 1 Mineral cast shower surfaces: Even more design freedom Page 4
- Mineral cast shower surfaces: Why mineral cast? Page 6
- Mineral cast shower surfaces: Variety that works Page 8
- 2 TECEdrainway shower channel: From the idea to the finished product..... Page 10
- 3 TECEdrainline shower channel: Seamless aesthetics..... Page 12
- TECElineo shower channel set: Elegance in black..... Page 13
- 4 TECEsquare toilet flush plate: Harmonious in every aspect Page 14
- 5 Coated toilet flush plates: Perfect match for design concepts..... Page 15
- 6 TECEloft Perfect Fit: Added value in the system Page 16
- Apartment building “The Brick Apartments”:
- Drinking water hygiene safely under control Page 18
- Upgrade for a TECE classic: Making good things even better Page 19
- TECE Adria: 20 years of success and a major milestone for TECE Page 20

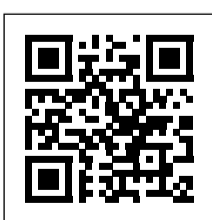

For more information, visit <https://spotlight.tece.com/>

Editorial

RETHINKING THE BATHROOM

Dear readers,

Germany's construction sector is on the move – in a noticeable way. Projects are being rethought, decisions are being made more consciously, and requirements are increasing.

Despite all the challenges, the market remains active and trends are gathering momentum. Seamless bathrooms, crisp lines and spacious areas. What generates enthusiasm on social media today ends up directly in the planning stage – and shortly afterwards on the construction site. Minimalist bathroom design is now much more than just a style. It has become an expectation. And meeting that expectation requires solutions that enable design freedom without compromising on functionality or safety.

That's precisely where we come in. TECE has always been thinking ahead in terms of technology – concealed in walls and floors, yet visible in its impact. With our new drainage solutions, we create genuine freedom for architecture and interior design. TECEdrainway and TECEdrainline for liquid floors are more than just technical accessories – they're tools for maximum design freedom. Minimalist in appearance, uncompromising in quality.

We are also applying this uncompromising standard to ourselves. We grow where it makes strategic sense and where it benefits our customers. The integration of Spanish mineral casting specialist hidrobox sends a strong signal: we are bringing leading expertise directly into our company. At the same time, we are continuing to invest in our European network – from logistics to production.

The future is created by embracing the new and being meticulous with the details. You'll discover exactly that in this edition of TECEnews: solutions that reflect the latest trends and make installations easier. And a TECE group that focuses more than ever on partnership, quality and further development.

Let's keep rethinking the bathroom together – as a space that makes every day better.

Sincerely,



Peter Fehlings



Peter Fehlings, Chairman of the Board



Mineral cast shower surfaces

EVEN MORE DESIGN FREEDOM

» In the second half of 2026, we will be expanding our drainage range with another highlight: three new mineral cast shower surfaces will be a perfect complement to our range. Whether flush with the floor or installed on screed, TECETones, TECUp and TECecore can be used flexibly making them the ideal choice for both new builds and refurbishments. Alongside our drainage products for natural stone, tiles and liquid floors, we offer maximum creative freedom for modern shower areas.«

Christian Schmalzel, Product Manager for Drainage Systems at TECE

TECEtones – Design with clean lines

TECEtones features a striking, linear geometry. The concealed drainage system and the surrounding edge, which slopes gently downwards, give it a sophisticated design. For everyone who values not just functionality, but also architectural clarity in their bathroom.





TECEup – The universal solution for any bathroom

With its classic design, TECEup integrates seamlessly into any bathroom. The drainage grate in the same colour as the shower surface emphasises the harmonious overall appearance and ensures a subtle, elegant look. A reliable choice for a timeless design and comfortable showering experience.

With the integration of Spanish mineral cast specialist hidrobox, TECE brings on board over 20 years of expertise in the development and manufacture of premium mineral cast bathroom products. The high-quality shower surfaces stand out not only through their exceptional material properties and pleasant feel, but also their clean, contemporary design.

TECEcore – Accents in brilliant white

Made from premium solid surface material, the TECEcore shower surface makes a clear statement in any bathroom. Its immaculate white surface and precise craftsmanship lend every room an air of exclusivity.

For everyone who values quality and design.

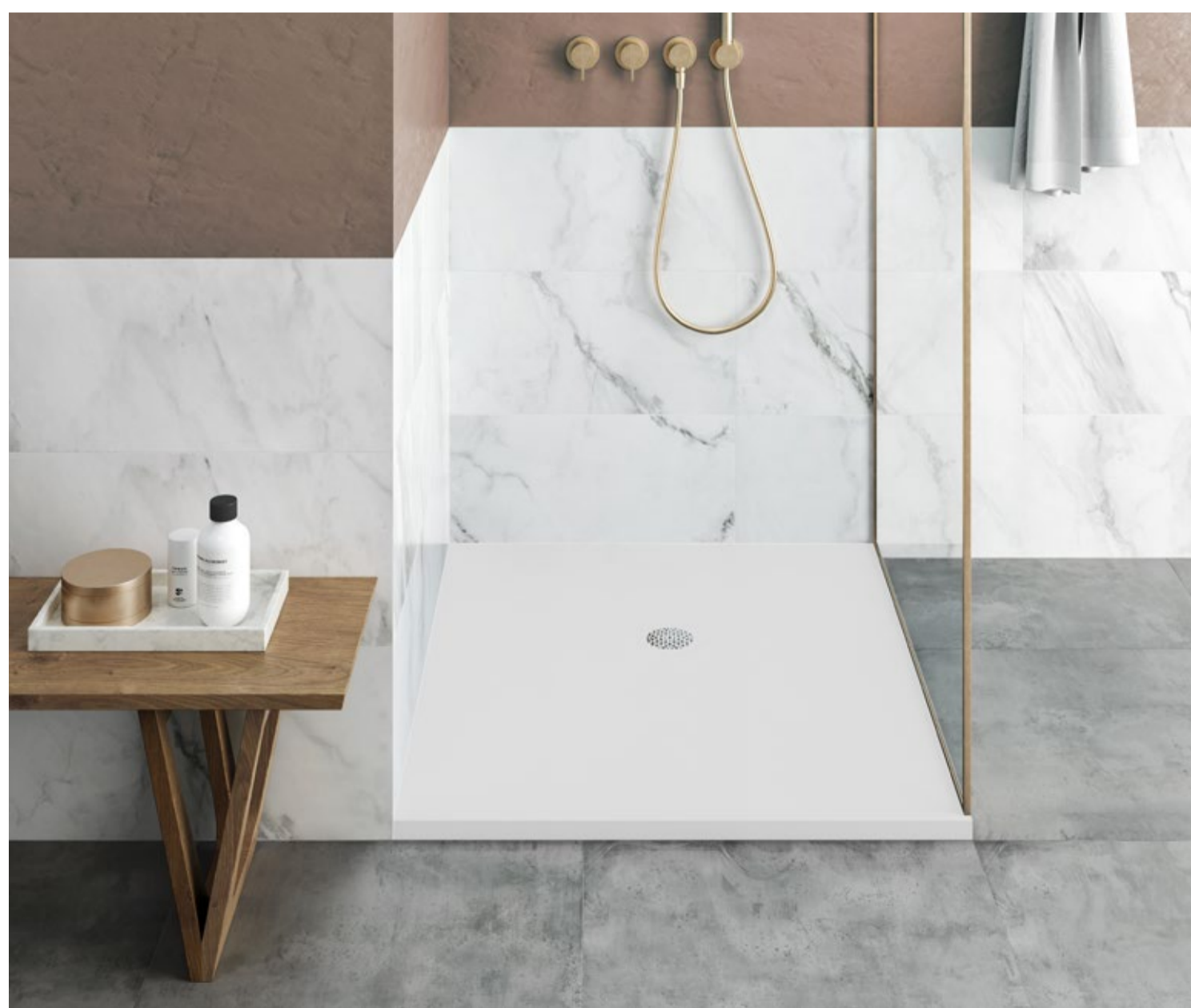

WHY MINERAL CAST?



» Mineral cast stands out thanks to its unique, soft and warm feel and sound-absorbing qualities. This makes it the ideal material for high-quality shower surfaces. Its easy-care, slip-resistant surface enhances safety and comfort. «

Alejandra Muñoz Galindo,
Head of Materials Engineering
hidrobox by TECE

Soft and warm to the touch

Mineral cast offers a velvety surface and low thermal conductivity. As body heat doesn't dissipate quickly, every touch feels natural.

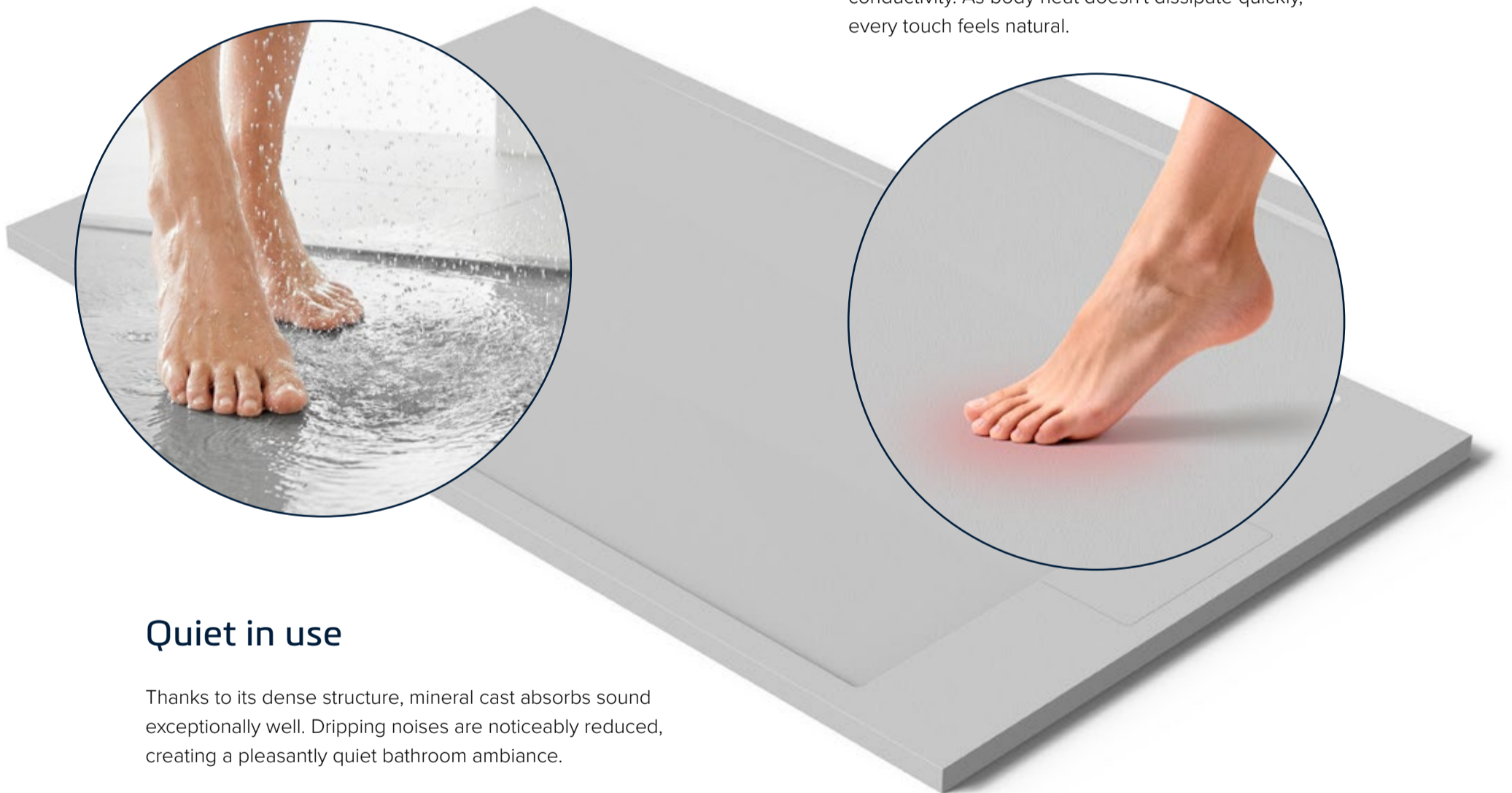

Quiet in use

Thanks to its dense structure, mineral cast absorbs sound exceptionally well. Dripping noises are noticeably reduced, creating a pleasantly quiet bathroom ambiance.

Advantages of mineral cast at a glance



Soft, warm feel



Sound-absorbing



Slip-resistant



Antibacterial



Homogeneous and non-porous



UV-resistant



Abrasion-resistant

Durable and versatile: offering outstanding material properties, mineral cast is an excellent choice for shower areas. It combines high strength with a pleasant feel and a wide range of design options – for a shower area that merges comfort and design perfectly. Depending on your requirements, TECE offers two material variants:



Coated

The compact composite of resins and mineral fillers features a high-quality gelcoat surface – known from shipbuilding, among other things – renowned for its excellent resistance to mechanical and chemical wear. This combination ensures exceptional toughness, high resistance to common hygiene products and easy cleaning with remarkable durability. In addition, the gelcoat can be coloured without any loss of surface quality. This makes the material ideal for creating coloured bathroom products.



Coloured throughout

The homogeneous solid surface material replicates natural materials with modern technology and surpasses them in functionality. Its innovative blend of mineral fillers, polymers and additives enables complex shapes, exceptional strength and a consistently premium appearance. With no external coating, its surface has the same properties as its interior. Fully coloured, it can be easily cut to size even at visible edges and adapted to individual structural conditions.



Microtex

Microtex offers a matt, uniform texture. Its microstructure creates subtle effects, ensures a smooth look from any angle and enhances slip resistance.

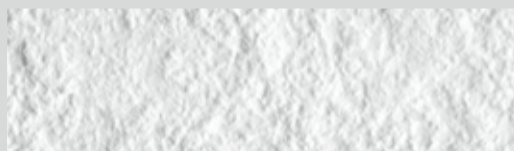

Slate

Slate is a surface that provides an authentic look. It pairs a natural look with excellent material properties, flawless craftsmanship and optimal slip resistance.

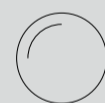
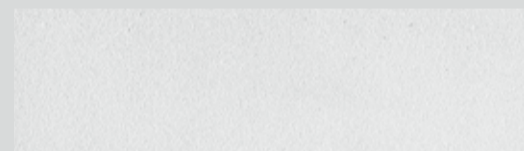

Smooth

The Smooth surface features a silky matt, even appearance and offers subtle slip resistance for use in shower areas.



Mineral cast shower surfaces

VARIETY THAT WORKS

Shower surfaces in various designs, colours and formats give you the freedom to customise your bathroom – from subtle to striking, to suit any room concept.

Installation options

Surface-mounted 

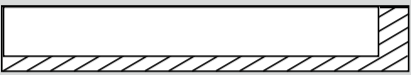
Floor-level 

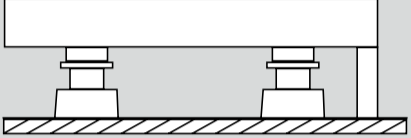
On feet 
Not suitable for TECecore.

TECEtones

More colour. More expressiveness.

TECEtones is available in 20 selected basic and trend colours. The wide range emphasises its striking geometry in an expressive way and opens up new creative freedom. Whether as a subtle touch or a bold statement, the broad colour range allows for customised bathrooms that complement any room concept. Tone-on-tone ensures harmonious elegance, while contrasting highlights create real eye-catchers. With TECETones, colour becomes a true design element.

Dimensions



W: 70–100 cm
L: 80–200 cm

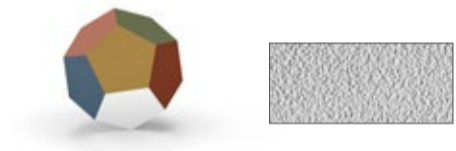

6 basic colours

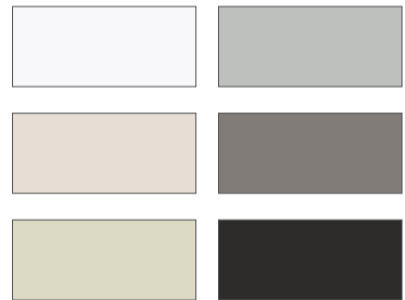

14 trend colours

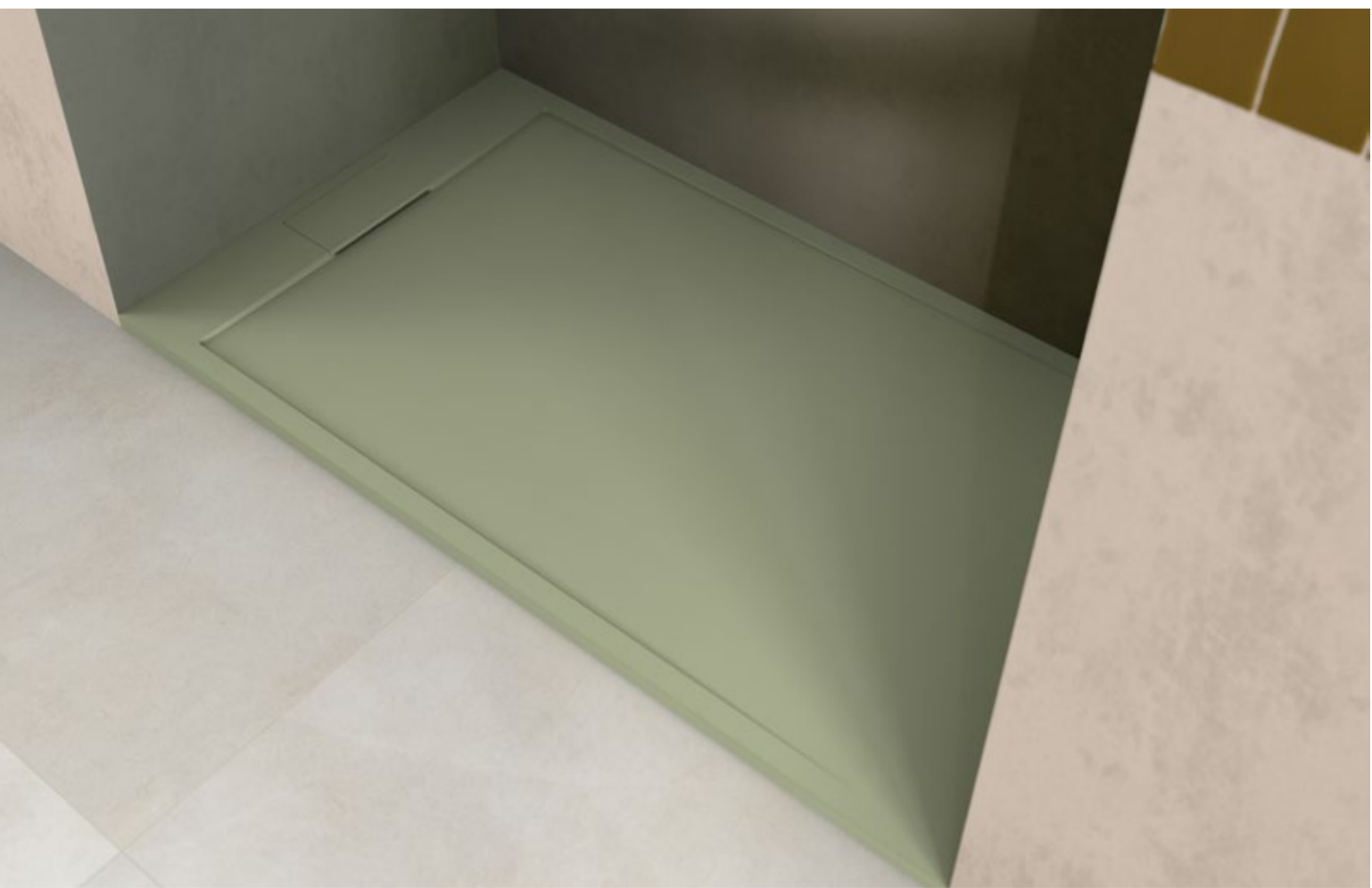

TECEup

Flexible and timeless

With its classic appearance, TECEup blends seamlessly into any bathroom. The six basic colours have been chosen to suit virtually any room concept – from purely functional to strikingly stylish. And when it comes to the details, TECEup also demonstrates its strength: the shower surface can be custom-cut on site at the edges that are not visible. From cut-outs for shafts and adjustments to niches to a precise fit for difficult floor plans – TECEup makes it easy to perfectly combine design and functionality.

Shapes and dimensions

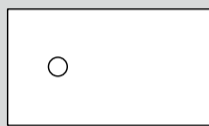

W: 70–110 cm
L: 80–180 cm

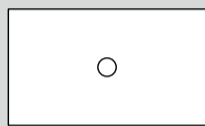

W: 70–110 cm
L: 190–200 cm



6 basic colours



TECEcore

Flawless down to the last detail

TECEcore is more than just a shower surface: it is a statement of highest quality. Made from solid surface material that is coloured throughout, it features a brilliant white surface, homogenous structure and precise craftsmanship. Thanks to the consistently identical material properties, not only the concealed edges but also those that remain visible after installation can be custom-cut on site. For example, to perfectly accommodate the subsequent tile grid – without any offset or uneven joints. As a result, the premium appearance is fully maintained – even for customised solutions.

Shapes and dimensions



W: 70–110 cm
L: 80–170 cm



W: 70–110 cm
L: 180–200 cm



FROM THE IDEA TO THE FINISHED PRODUCT

The new TECEdrainway shower channel has been on the market since late 2025. From the initial idea to installation on the construction site, the shower channel has passed through several milestones: from that idea a prototype has been born. It was then put through thorough testing and was optimised. This led to the pilot series, which underwent extensive field testing and norm testing in the laboratory. Only after this did full-scale production begin.



» Testing is essential to our product development process. Here, a fixed number of samples are tested from selected customers under real-life conditions. One of the last major milestones in quality management before full-scale production.«



Christian Hüging, Product Manager for Drainage Systems

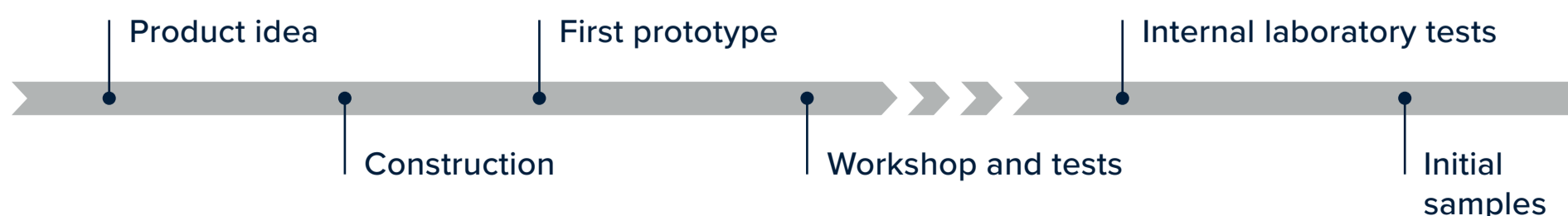



Extensive laboratory testing

The DIN EN 1253 specifies requirements and corresponding test procedures for drains in buildings. Throughout product development and production monitoring, TECE tests samples according to these procedures – both in its own labs and with external agencies. One vital test for shower channels is assessing their self-cleaning ability (pictured). Other essential tests include drainage capacity and sound insulation.

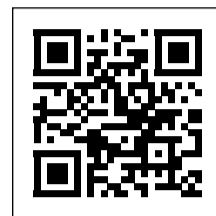

QR code for the video

Qualified testing

Qualified testing marks a key stage in product development. Here, future users test the product independently and under real conditions. This process reveals whether instructions, components and installation steps are clear and user-friendly, and whether the product performs as expected on the construction site. This impartial practical check highlights any remaining weaknesses and ensures that the product is reliable and user-friendly before it is launched on the market.

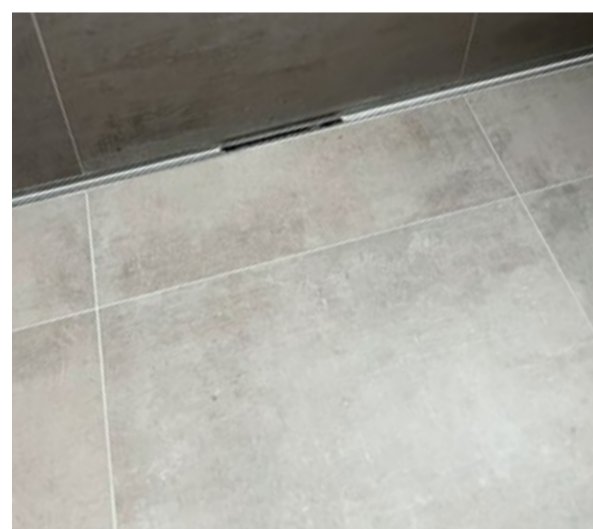
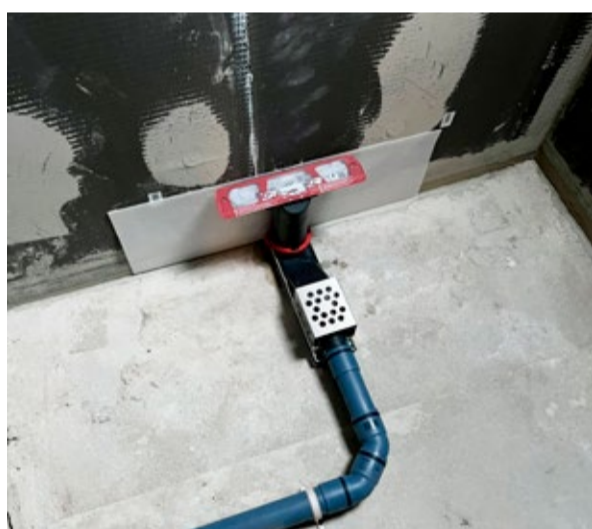
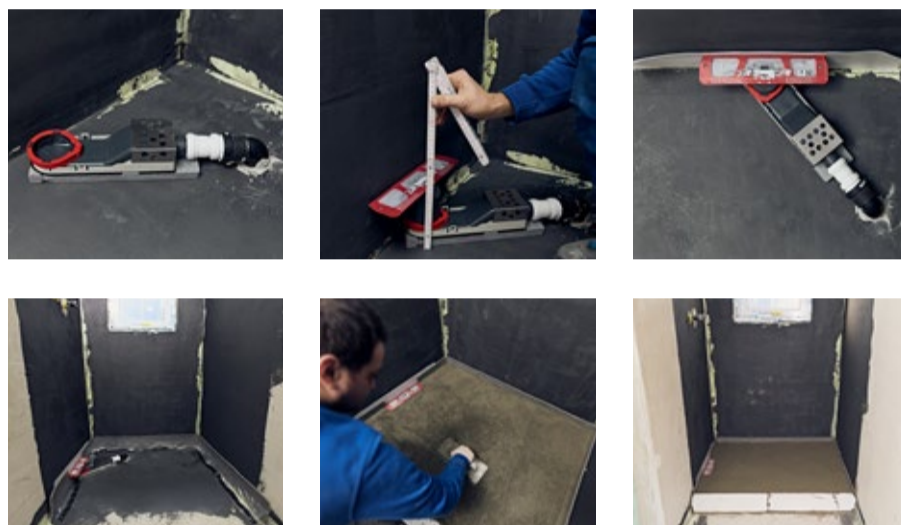

Safe. Reliable. And ready for the world.

Once field tests and laboratory tests have been successfully completed, preparations for market launch begin. Production is ramped up, initial inventory is built, and both internal and external training sessions take place. Brochures, documents and communication materials are now also available. With the official launch, the first pallets leave the warehouse – and TECEdrainway is now being installed by professionals all over Europe.

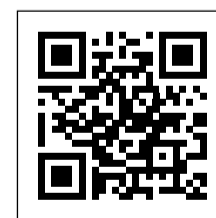
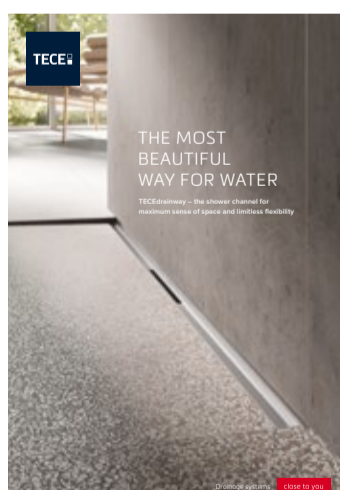

Download the TECEdrainway brochure from our website.

**Tested in accordance with
DIN EN 1253 and DIN 18534**

**Conformity assessment at
a recognised testing centre**

Field tests

Sales launch

TECEdrainway has been available since December 2025.

TECEdrainline shower channel

SEAMLESS AESTHETICS

Until now, enthusiasts of seamless floor coverings in shower areas had to make compromises – a visible channel was usually unavoidable. With TECEdrainline for liquid floors, compromises in creating a seamless shower area are now a thing of the past: this solution delivers a seamless, minimalist look without any interruptions in the material – for a bathroom that looks as if it was cast from a single mould.



Clean, light, exclusive

Seamless bathroom design offers visual calmness and a sense of space. With a variety of modern materials available, this minimalist bathroom style has celebrated a strong comeback in recent years.

The reasons are obvious: seamless surfaces provide the impression of enhanced space. The fewer visual anchors the eye detects on floor or wall, the larger the room appears. Besides that microcement and mineral smoothing compounds offer almost unlimited possibilities when it comes to colours and textures, allowing for distinctive, inviting designs with a personal touch. Added to this are the pleasant feel and reduced sensitivity to limescale and dirt deposits.

With the TECEdrainline shower channel, TECE now offers the option of extending levelled floors into the shower area without interruption. This is achieved thanks to a mineral cast coating on both the channel flange and cover, ensuring an optimal bond for screed finishes. All that remains visible is the slim water inlet. The result is a harmonious bathroom setting that brings together seamless functionality and restrained elegance.



» A perfectly seamless bathroom is more than just design: it's the outcome of refined craftsmanship and perfectly coordinated products. Only this combination creates a space that is not only beautiful but also durable. «

Andreas Tasch, CEO, Murface GmbH

TECElineo shower channel set

ELEGANCE IN BLACK: TECElineo EXPANDS THE RANGE



13

The TECElineo shower channel set guarantees smooth water drainage with no interfering corners or edges. Thoughtfully engineered and with a clean design, it integrates flexibly into any bathroom layout. It is now available in brushed stainless steel and – brand new – with black PVD coating. The stainless steel profile can be shortened on either side from 1000 mm to as little as 400 mm, allowing it to be adapted exactly to

the dimensions of any shower area. A sealing collar to create the secure composite seal is included in the set. The hinged flange on the drain body makes it possible to install the channel flush with the wall on structures of at least 10 mm, including tile adhesive. Height and parallel adjustment are just as easy as cleaning thanks to the optimised internal gradient.



'ALL IN ONE SET' TECElineo shower channel set,
1000 mm x 65 mm, black

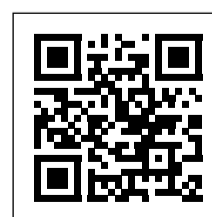

Watch here how to install
TECElineo



TECEsquare toilet flush plate

HARMONIOUS IN EVERY ASPECT

14

Four new surfaces, one truly harmonious look: TECEsquare fits seamlessly into modern bathroom settings.

With four new surfaces, TECE is now giving the TECEsquare toilet flush plate even more expressiveness. Nickel, bronze, brass and black stainless steel expand the range of designs with sophisticated, on-trend shades that are the perfect match—not only for current collections from leading fitting manufacturers, but also for our own TECEdrainway or TECEdrainprofile shower channels. This leads to bathroom designs that are completely harmonious – from the washbasin and shower to the toilet. Whether a striking or subtle effect is wished for, the new colour options add exciting touches or blend stylishly into the overall look. With premium materials and meticulous craftsmanship, they are visually impressive and offer long-lasting functionality. All four new surfaces feature an anti-fingerprint coating, which makes cleaning and maintenance noticeably easier. If you wish to design your bathroom with meticulous attention, the new TECEsquare range offers the optimal solution for a perfectly harmonious look - clear, modern, and absolutely cohesive.

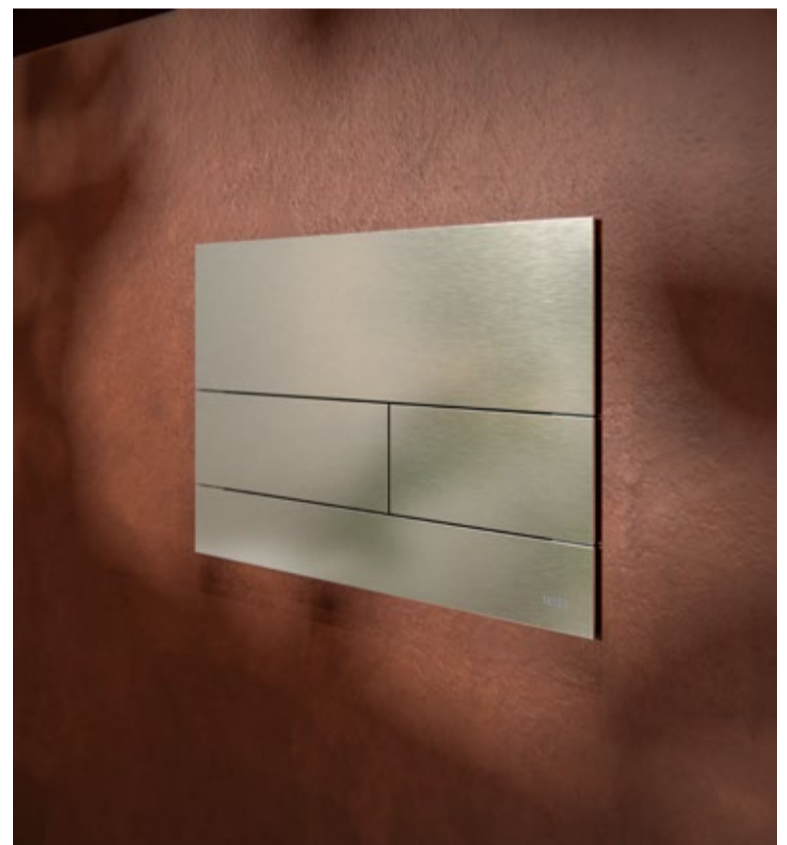

Elegant contrast: the TECEsquare toilet flush plate in brushed cool nickel against a rust-brown surface.

The toilet flush plates will be available from mid-February 2026.



Brushed cool nickel



Brushed bronze



Brushed brass



Brushed black

Coated toilet flush plates

PERFECT MATCH FOR DESIGN CONCEPTS

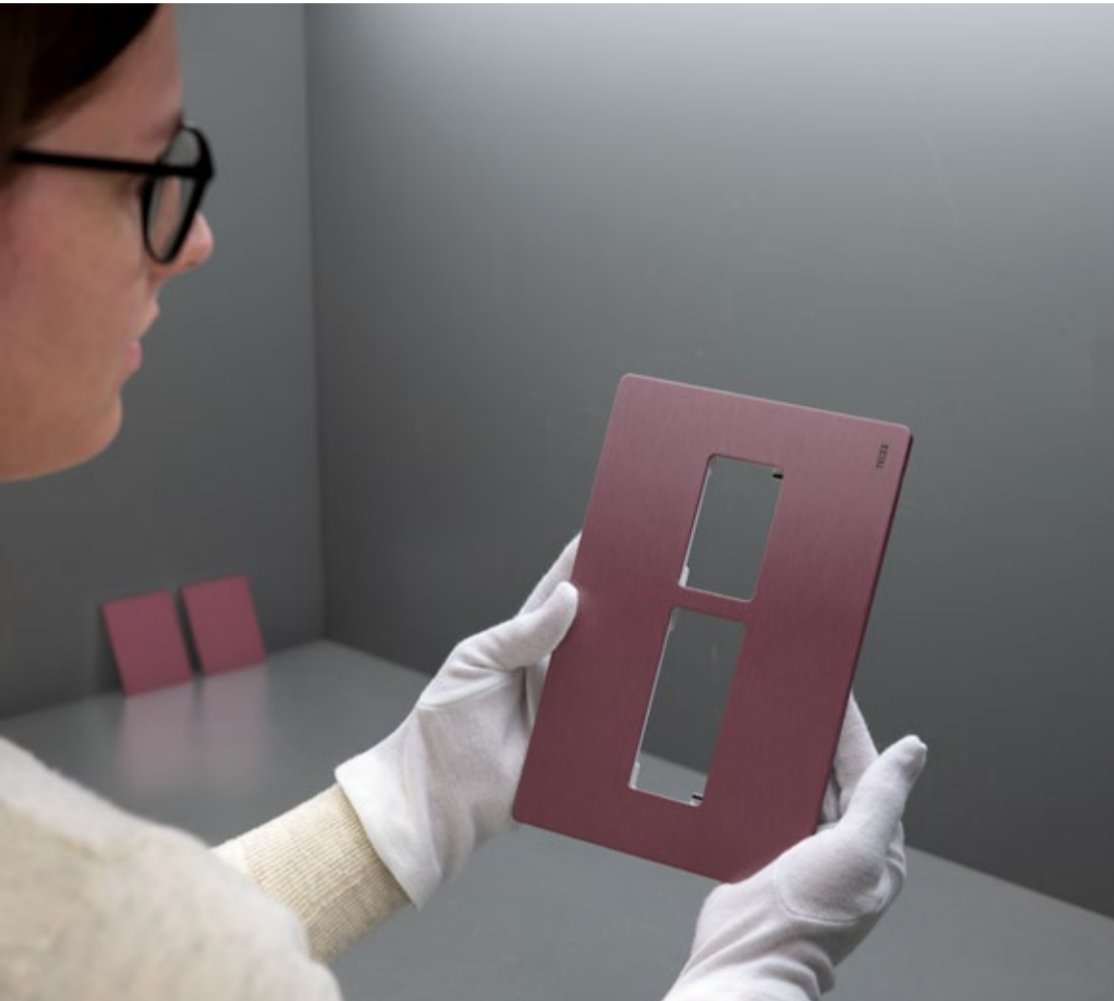

For larger projects, TECE now provides toilet flush plates in preferred colours.

If you're going retro, go all the way! Sprayed in Bahama beige. Perfectly matched to your toilet. Or perhaps in the curry yellow of your hotel chain's corporate design? Or maybe that one vintage fitting in brushed nickel is just the thing for a period apartment block. In any case, a toilet flush plate that perfectly matches the design concept of a bathroom is always a statement of meticulous attention to detail.

On request, high-quality paint finishes in bespoke RAL colours, paint finishes in standard, retro and ceramic colours, and sophisticated galvanic surfaces are possible for orders of 25 or more – for the TECEsquare, TECEsolid, TECEloop, TECEnow and TECEflushpoint series. Making visions a reality – down to the last detail.

The choice is yours

				
RAL Classic colours (paint finish)	Galvanic surfaces (metallic coating)	Standard, retro and ceramic colours (paint finish)		
				
216 colours available from the RAL Classic range	A layer applied by galvanisation in a wide variety of metallic colours	Inspired by ceramic colours both past and present		



Everything coordinated – customised colour design for TECE toilet flush plates.

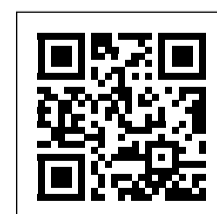

Visit our website for all information about the range and ordering process for TECE flush plates with customised surfaces.

Available from April 2026.

TECEloft Perfect Fit

ADDED VALUE IN THE SYSTEM

System technology makes all the difference. Only the precise interaction of all components creates maximum efficiency. With its perfectly coordinated programme of system components, TECE offers a complete solution that you can rely on – reliable in every detail, effective as a complete system.



To ensure optimal interaction between all components, TECE tests its toilet ceramics with all TECE toilet modules in its in-house laboratory. The low toilet modules with low flush volumes and the high toilet modules with large flush volumes are particularly interesting from a hydraulic point of view. For low hydrostatic heights and small volumes, TECE tests the washdown flush as well as the flushing efficiency in line with DIN EN 997; with larger installation heights and high flush volumes, preventing splashing is the focus. In practice, Perfect fit means: from the box straight onto the wall – for the perfect flushing results, with no adjustments needed.

Perfect combination

Perfect fit ensures that TECEloft always delivers the best results when combined with any TECE toilet module. This guarantees a strong, effective flush even in compact installations and with smaller flush volumes. Meanwhile, sophisticated geometry prevents splashing, even with large installation heights and high flush volumes.





Test bench for product development

To guarantee seamless compatibility between TECE cisterns and toilet ceramics, a range of tests in accordance with DIN EN 997 are performed on test benches in the TECE laboratory, simulating different hydraulic conditions. The most important standardised tests for the combination of cisterns and toilet ceramics focus on rinsing, effective flushing of paper and spheres as well as splashing. These examinations are carried out at various hydrostatic head heights and with differing flush volumes.

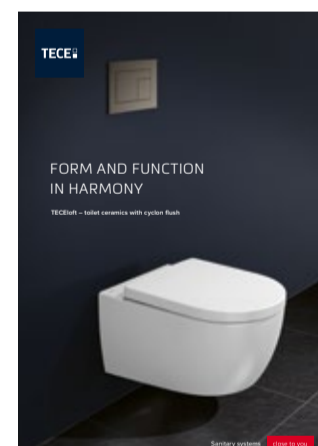

You can find the video and more detailed information on our website.

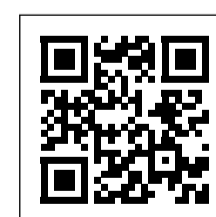

QR code for the video

Results you can trust

From the smallest TECE toilet module with just a 4-litre flush, to the largest with 9 litres – TECEloft and TECE flushing technology deliver impressive performance as a system.

TECEloft will be available from February 2026.



Drinking water hygiene

DRINKING WATER HYGIENE SAFELY UNDER CONTROL

In the heart of the kubaai quarter in Bocholt, “The Brick Apartments” is a cutting-edge apartment building that is specifically designed for young people. Modern rooms, smart sanitary technology and safe drinking water hygiene make it a place that lives up to its name.

This four-storey new build offers 50 contemporary apartments, each around 25 m² in size, complete with private bathroom and French balcony. Here, micro-living is redefined as a lifestyle, blending comfort, safety and flexibility in perfect harmony. Architectural design remains distinctive, drawing clear inspiration from the site's history: the characteristic red-brown clinker bricks, typical of the Münsterland region, pay tribute to the Herding site's industrial heritage.

In contrast, the sanitary technology is designed for the future. The compliance with drinking water hygiene is ensured by toilet modules equipped with an integrated hygiene flush. This guarantees a complete exchange of cold and hot water in the pipes, even when the apartments are unoccupied, and effectively prevents the growth of potentially harmful bacteria. This means that the flushes do not have to be triggered manually, which can be time-consuming, but are carried out automatically via a Bluetooth-programmed control system. This effectively saves operators time and money and enables them to fulfil their responsibility for properly operating drinking water systems comfortably, safely and economically. The logging function provides evidence of compliance with proper operation, providing optimum safety for operators.

Already thinking about tomorrow

What's particularly clever is that the tried-and-tested TECEprofil toilet modules with integrated hygiene flush come fully equipped with everything needed for future IoT remote access, paving the way for web-based control. This enables simple centralised management of multiple properties – maximising safety with minimal effort.



- ✓ Bluetooth
- ✓ Internet

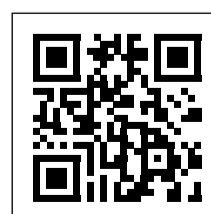

Take a look: this is how the TECEprofil toilet module with integrated hygiene flush works.

Upgrade for a TECE classic

MAKING GOOD THINGS EVEN BETTER

TECEprofil washstand module
with optimised water pipe

SAFE AND SOUND, EVERY BIT OF IT

The new TECEprofil washstand module with factory-assembled water meter units leaves nothing to be desired: the entire water pipe – from the concealed valve to the ½" connection T-piece for angle valve mounting – is not only pre-assembled but also fully insulated. This applies both to the module with separate hot and cold water pipes and to the version with only a cold water pipe. The insulated, lockable mounting blocks are suitable for mounting standard water meter measuring capsules with coaxial G2" connections. What's particularly practical is that the ½" outlet is compatible with our Seal System sealing sleeve and the matching reusable construction plug. This ensures that the installation of the TECEprofil washstand module for water meters is not only straightforward but also reliably leak-proof.

The products will be available from February 2026.

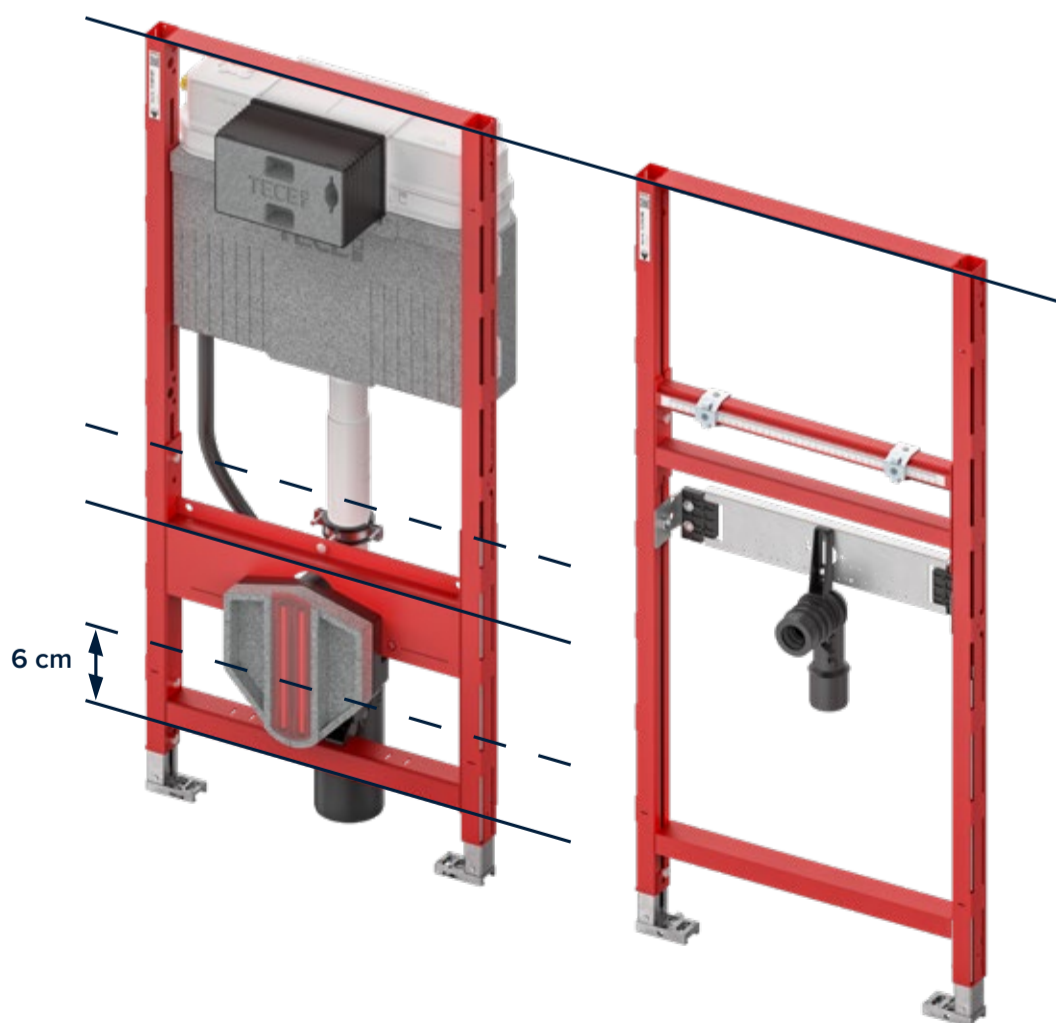

TECEprofil toilet module
with adjustable seat height

FLEXIBILITY DURING SHELL CONSTRUCTION

It's no secret that things rarely go exactly to plan on construction sites. It is not uncommon for customers to request changes at the eleventh hour. Especially when it comes to details that aren't immediately obvious, such as the height of the toilet ceramics. Once the entire pre-wall construction has been meticulously planned, the height-adjustable TECEprofil toilet module in the standard 1120 mm dimension makes subsequent adjustments far simpler. With this, the height of the ceramics in the shell construction can be raised by up to 6 cm, without altering the height of the pre-wall. This keeps both toilet and washbasin modules perfectly aligned. The cistern remains unchanged in its position, while height adjustment is carried out precisely via the integrated sliding frame and the movable flush pipe. The toilet module remains as robust as ever: both shower toilets and extended ceramics for accessible solutions can be effortlessly mounted on the crossbeam with the appropriate wall fittings. This enables you to adapt easily to any modification without sacrificing stability or comfort.

The products will be available from June 2026.

TECE Adria

20 years of success and a major milestone for TECE



The opening of a new logistics and business centre in Zagreb (Gornji Stupnik, Croatia) marks not only a major milestone for the TECE Group, but also celebrates the 20th anniversary of our successful subsidiary TECE Adria.

Since its establishment in 2005, TECE Adria has grown into a cornerstone of the European organisation. Today, numerous markets across South-East and Central Europe are managed from Zagreb. This region has evolved into a vital growth driver and plays a crucial role in strengthening TECE's position in the European market. Customer loyalty, a strong partner network, and deep market insights are the foundation of this success.

The anniversary also emphasises the company's future resilience. Through targeted investments in infrastructure, logistics and production

capacities – including in South-East Europe – TECE is paving the way for further international growth, exceptional delivery capacity, and technological excellence. Modern facilities with showroom, training, and logistics capabilities support our unwavering commitment to service quality and knowledge development in the markets.

20 years of TECE Adria stand for reliability, innovative strength and strategic foresight. They reflect how TECE is continually expanding its European presence while laying the foundations for a sustainable and internationally successful future.

TECE SE
International Business
T +49 2572 928-999
international-business@tece.de
www.tece.com/en

TECE Limited
T +4417 61 24 11 33
info@tece.co.uk
www.tece.co.uk

TECE 
close to you

Appearance and texture may vary depending on material, manufacturing process and lighting conditions.
In order to improve the flow of reading, no distinction is made between feminine, masculine and non-binary in gender-related expressions. However, all genders are always implied.