

TECEdrainprofile shower profile

**ELEGANT
DESIGN,
IMPRESSIVE
TECHNOLOGY**





DESIGN THAT SIMPLY FITS

Good product design is often characterised by the fact that you hardly notice it. For example, when the shower drainage fits perfectly into the room, both spatially and visually, and makes cleaning so easy. Like TECEdrainprofile.

“When it comes to shower profiles, I look for three things: a wide range of designs to choose from, easy installation and simple cleaning.”



It simply looks good.

With its attractive design and the wide variety of colours and surfaces, TECEdrainprofile offers a solution for every bathroom style.

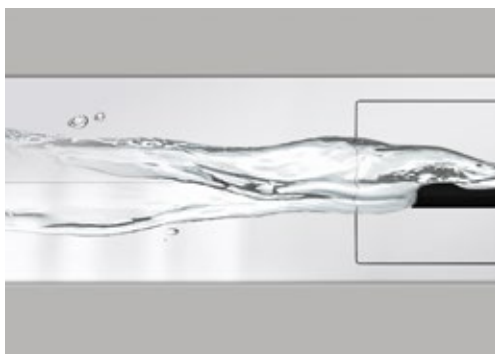
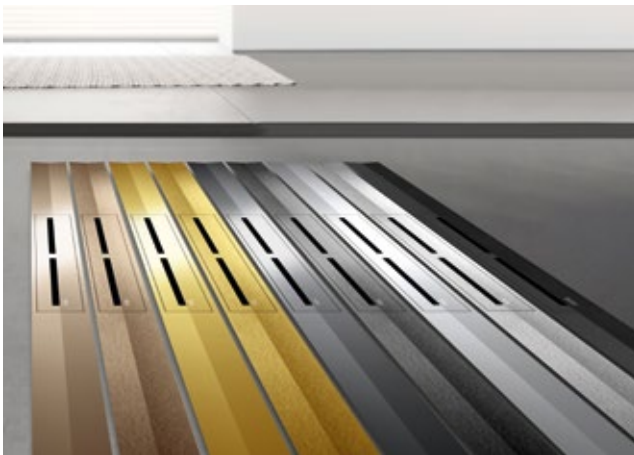

Simply stays clean.

The inner gradient optimises water drainage and the self-cleaning effect and reliably prevents puddles from forming.

Simply fits perfectly.

Whether recessed or in the room: clever features enable a simple and precise installation in every case.

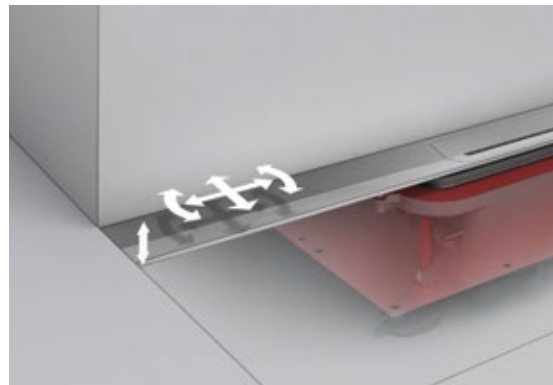

The advantages

- Attractive design
- Easy assembly thanks to clever product details
- Available in up to five lengths from 800 to 1600 mm
- Can be cut to size on both sides for recessed installation
- Matching the current trend collections of leading bathroom fitting manufacturers
- Conforms to DIN EN 1253 and DIN 18534 standards
- The simplest cleaning for perfect hygiene

EVERYTHING FLOWS SMOOTHLY.

Where no corners and edges slow down the flow, everything runs smoothly. Pleasant both for the eye and for hygiene.



Perfectly integrated

The stainless steel profile is available in different lengths and can be shortened to 500 mm. This allows the recessed installation of the shower profile, eliminating the need for tile pieces on the side. This is an advantage, especially with large tiles and natural stone.

Clean in no time

How do we imagine a shower profile? Attractive, practical and with properties that simplify cleaning decisively. Like TECEdrainprofile.

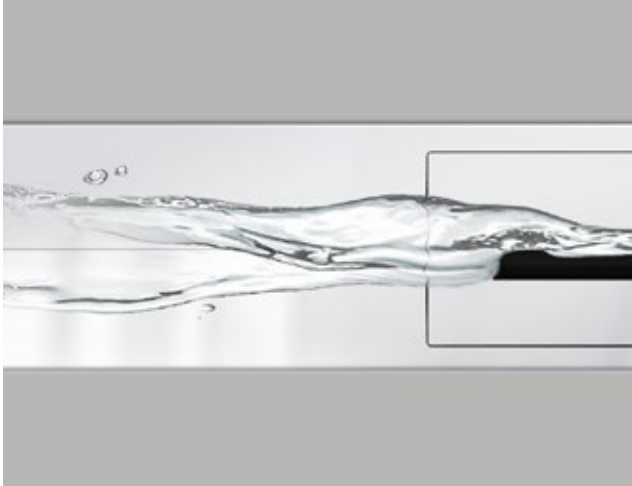

With self-cleaning effect

The inner gradient optimises drainage of water and the self-cleaning effect, thereby also reducing the amount of cleaning required.

At the same time, it reliably prevents puddles from forming.

With the simplest means

Rinse, wipe, done: a simple cloth is enough to clean the low-maintenance stainless steel shower profile.

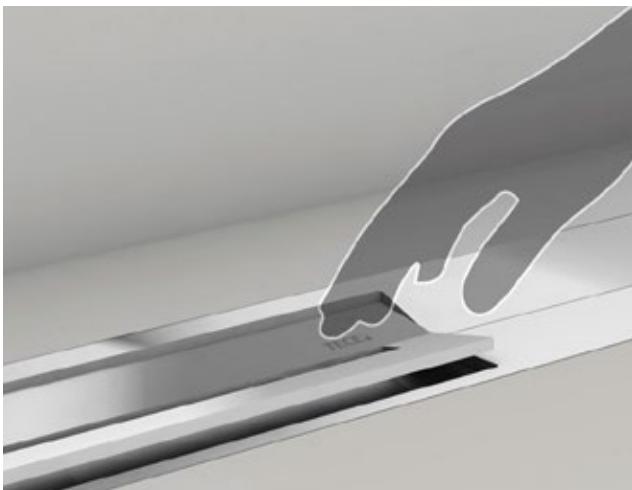
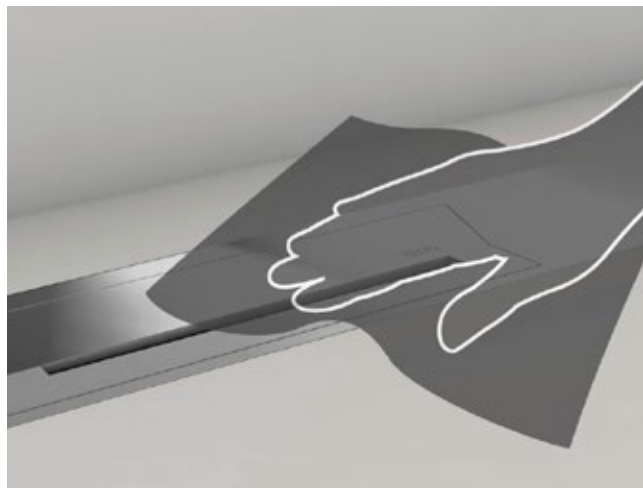

With push function

The profile lid can be folded up at the press of a finger and removed without tools – for easy access to the drain line and for removing the odour trap.

WELCOME TO THE JUNGLE

Modern Red Gold acts as a harmonious counterpart to botanical tones and raises them to a new level.

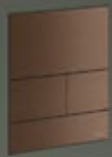



BRAVE NEW WORLD.

Walls, floors and bathroom fittings with personality create rooms with character. The matching shower profile makes them perfect "from head to toe".

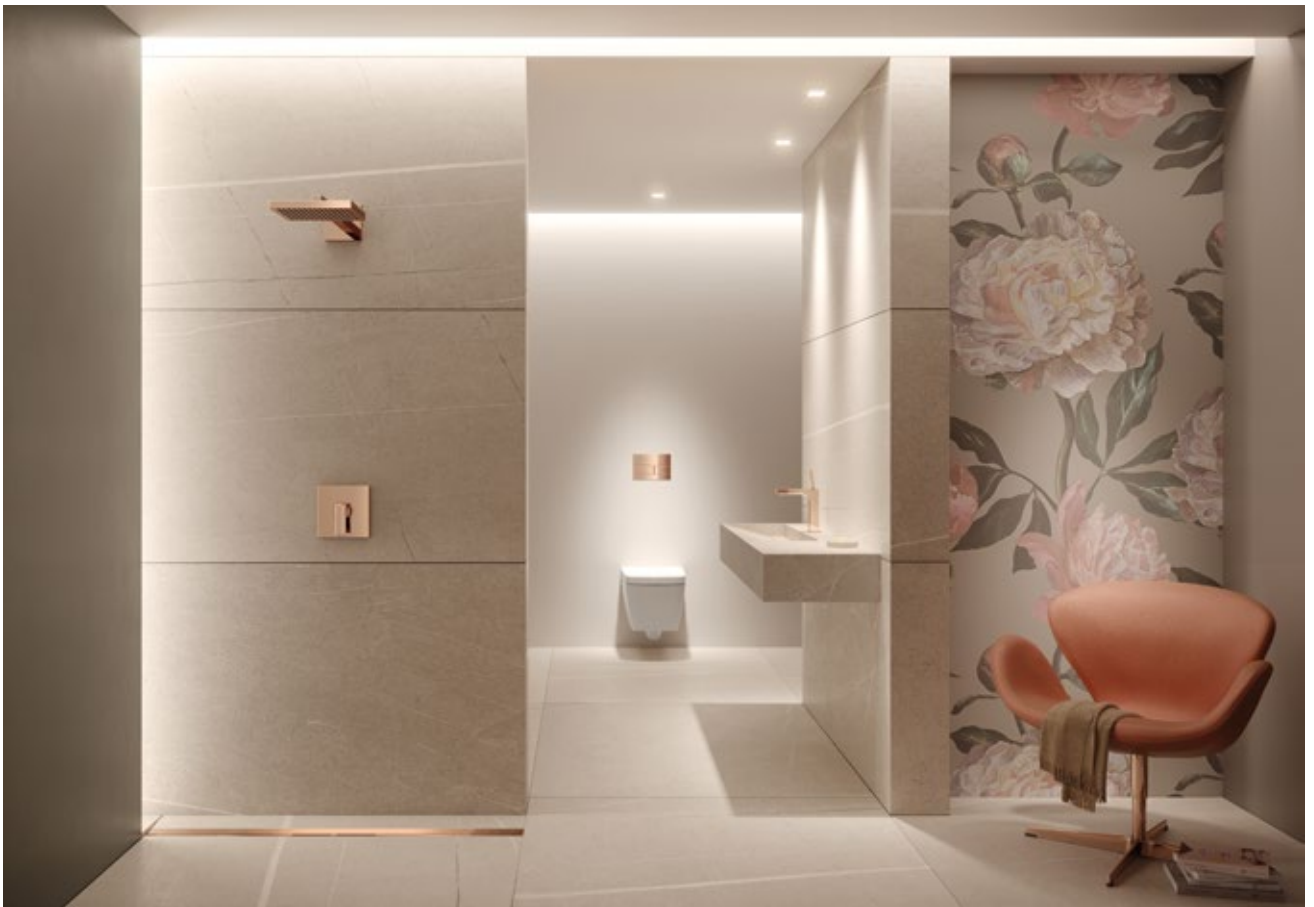

As if from a single mould

From a modern botanical look to a romantic boudoir. The flush plate and shower profile create a harmonious overall impression with identical bathroom fittings in warm Red Gold.

TECEsquare toilet
flush plate in
Red Gold Brushed.

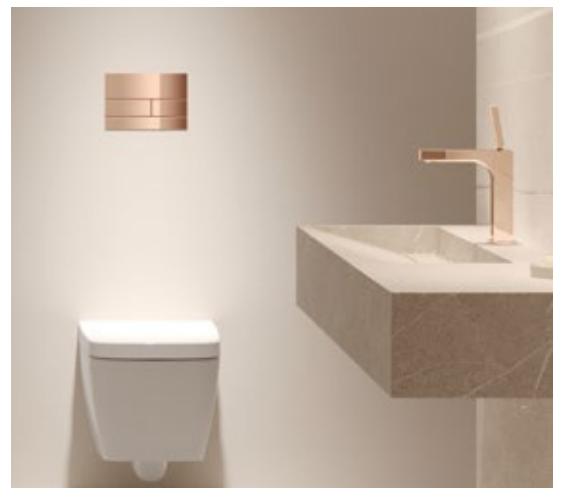



True designer pieces. Without airs and graces.

The new PVD surface-finished products in the TECEdrainprofile and TECESquare metal ranges are colour-coordinated with the surfaces from hansgrohe/Axor and can be combined with the trend collections from leading bathroom fittings manufacturers. For harmonious bathroom planning down to the finest detail.



The new surface finishes for the TECESquare and TECEdrainprofile ranges are available in four modern tones, each as a polished and brushed version.



Gold Optic
Polished/Brushed



Red Gold
Polished/Brushed

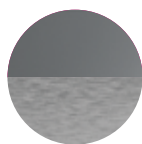

Black Chrome
Polished/Brushed



Brushed Black
stainless steel









Highly refined

The visible stainless steel parts of TECESquare metal and TECEdrainprofile are finished with the PVD technology. This is what makes their surface so brilliant and colour-intensive, as well as extremely resistant to scratches and abrasion.



TECEdrain profiles

Collection overview

Length		800 mm	900 mm	1000 mm	1200 mm	1600 mm
Surface		Item no.	Item no.	Item no.	Item no.	Item no.
	Brushed Stainless Steel	670800	670900	671000	671200	671600
	Polished Stainless Steel	670810	670910	671010	671210	
	Brushed Black Stainless Steel	670821	670921	671021	671221	
	Brushed Black Chrome	670801	670901	671001	671201	
	Polished Black Chrome	670811	670911	671011	671211	
	Brushed Gold Optic	670802	670902	671002	671202	
	Polished Gold Optic	670812	670912	671012	671212	
	Brushed Red Gold	670803	670903	671003	671203	
	Polished Red Gold	670813	670913	671013	671213	

Drain

The drain range of the TECEdrainprofile programme consists of a “flat” drain, a “standard” drain and a vertical drain.

The vertical drain is suitable for all applications in which the drain pipe is to be routed directly vertically through the ceiling. At 47 mm, it is also the flattest drain in the range.

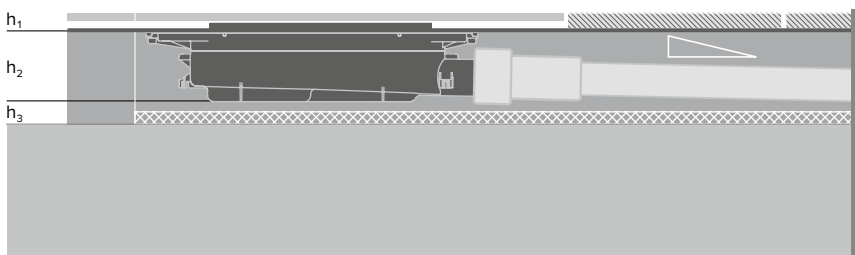

- h₁ Height of shower profile / floor covering 8 - 25 mm (incl. adhesive bed)
- h₂ Height of drain to upper edge of screed
- h₃ Height for sound insulation or isolation and drain line gradient

Drain	h ₂ [mm]	Performance [l/s]
Flat	65	≥0.46/≥0.53*
Standard	95	≥0.6/≥0.8*
Vertical	47	≥0.8/≥1.2*

* With 10/20 mm build-up height in accordance with DIN EN 1253-1



THINK BIG

With the new TECEdrainprofile 1600 mm in brushed stainless steel, you can also drain large-format showers flush with the niche, without splitting over the entire width of the shower area.



CONSTRUCTION SITE FAVOURITE

Clever technology for simple installation

With TECEdrainprofile, we not only meet visual requirements with an attractive design, we also meet every requirement in terms of safe, reliable and fast installation thanks to the numerous clever processing details, such as the stable attachment, simple height compensation or the click-in seal.

More design freedom

The stainless steel profile can be shortened on both sides and hence be adapted exactly to the dimensions of any shower area. This creates an aesthetic overall impression without tile fragments on the sides especially with large-format tiles.



Sealed with a click

The factory-supplied Seal System sealing sleeve allows a water-tight connection – simply by clicking in.

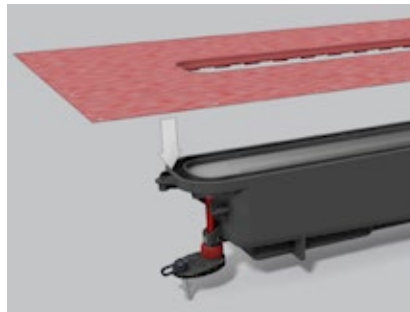

TECEdrainprofile has also been tested according to the safe Seal System sealing standard – successfully!

1

The stainless steel is installed recessed and can be shortened on both sides where required. This means it can be precisely tailored to the width of the shower area.

2

For floor coverings from 8-25 mm (incl. adhesive bed).

For installation flush with the wall and for wall coverings from 10 mm (incl. adhesive bed).

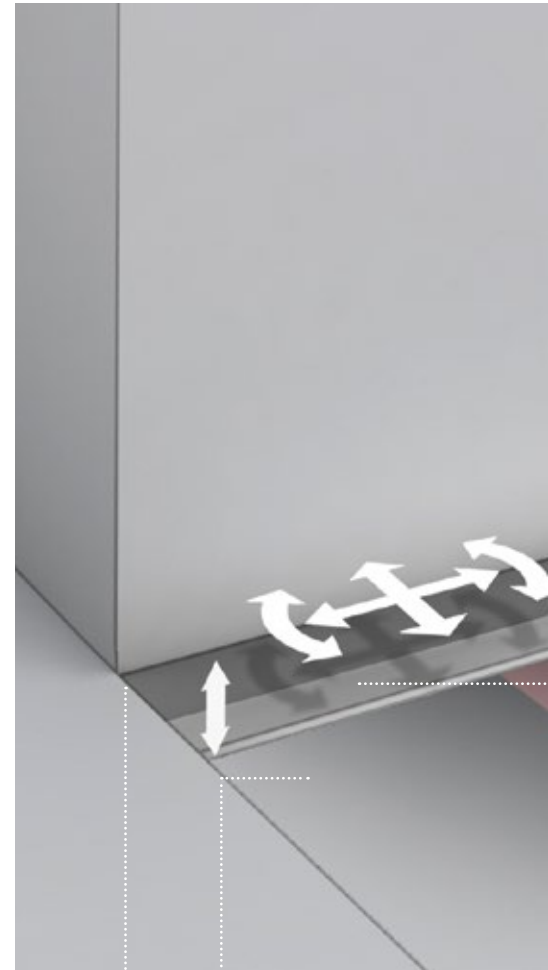

DIN
18534
compliant

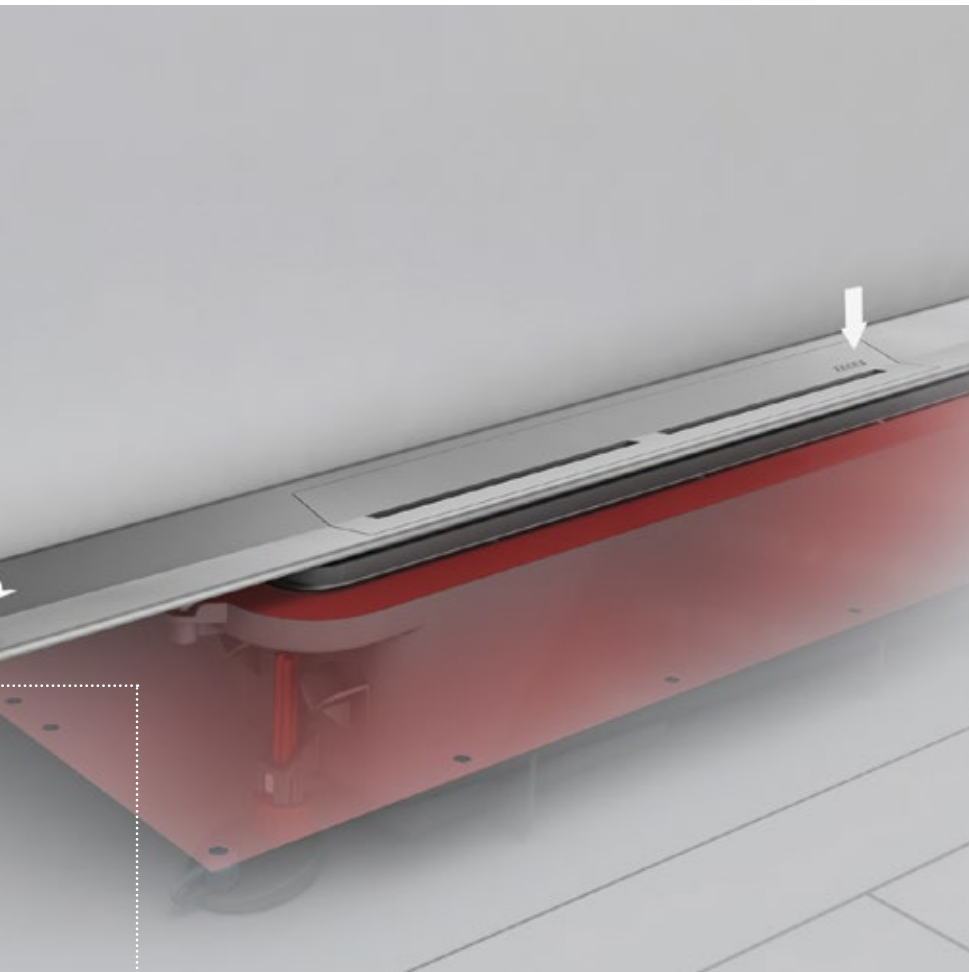

Wall bracket

The newly developed bracket makes installation of the TECEdrainprofile shower profile even easier, more stable and more precise.

The shower profile remains exactly in the desired position when the screed is laid.

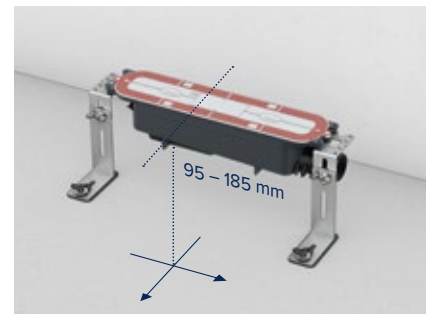

3

The shower profile can still be finely adjusted both horizontally and vertically even after the drain is mounted in the screed.



For more information on
TECEdrainprofile visit
www.tece.com/en.

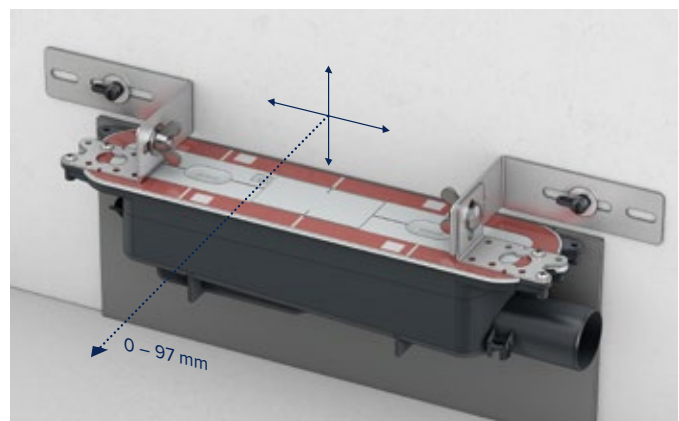



Illustration	Product	L x W in m	Item no.
	TECE drainline "Standard" drain, DN 50 side drain		673002
	TECE drainprofile "Flat" drain, DN 40 side drain		673001
	TECE drainprofile "Vertical" drain, DN 50 drain		673003
	Sound insulation mat 6 mm Drainbase (roll)	8.00 x 1.25	660002
	Sound insulation mat 6 mm Drainbase (mat)	1.25 x 1.25	660001
	TECE drainprofile Assembly feet		674000
	TECE drainprofile wall and floor-mounting bracket		674001
	TECE drainprofile hair trap, stainless steel		674002
	TECE drainline fire protection set FireStop EI 120 DN 50		660006

For more information visit
www.tece.com/en

TECE GmbH
T +49 25 72/9 28-999
international-business@tece.de
www.tece.com