

# TECE NEWS

TECEprofil universal cisterns



## New for 2021

Practical flushing technology upgrade:  
**TECEprofil universal cisterns**

New flush plate: **TECEvelvet**

New surfaces:  
**TECEloop & TECEdrainprofile**

Digital innovations platform:  
**TECESpotlight**

New cold water variants:  
**TECEone & hygiene flush**



TECEvelvet toilet flush plate



TECEloop concrete toilet flush plate



1



2

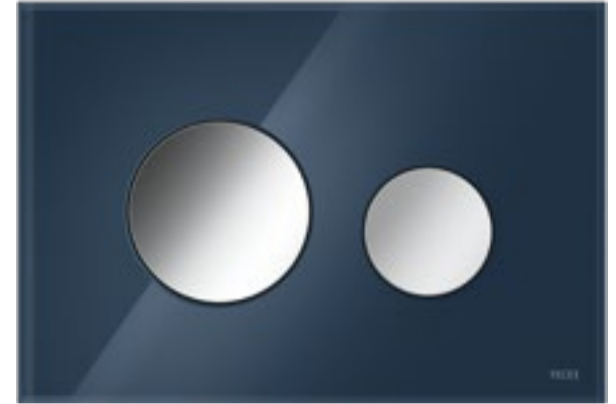

3



5

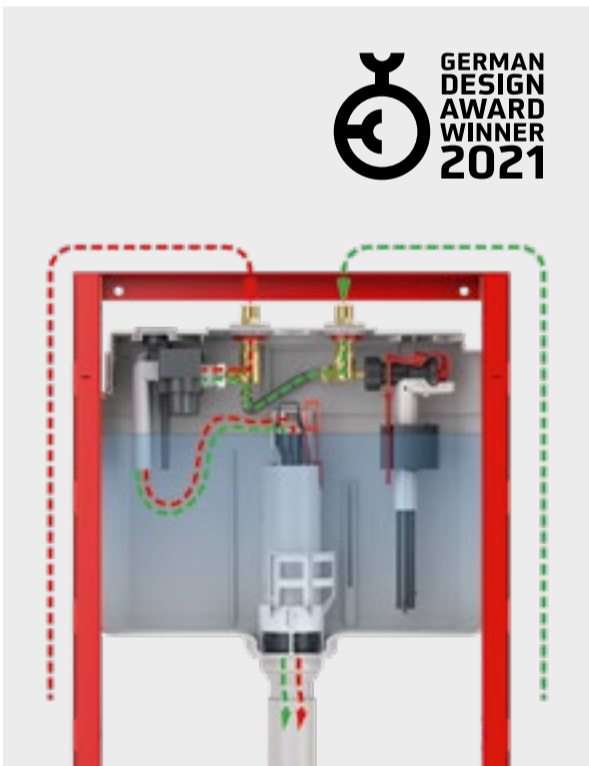

4



6

- 1 **TECEprofil: Practical flushing technology upgrade** ..... Page 4
- 2 **TECEvelvet: New toilet flush plate with innovative surface** ..... Page 8
- 3 **TECEloop: New surfaces and colours**..... Page 10
- New trending colours for the flush plate range** ..... Page 12
- TECEdrainprofile: Dark black coating** ..... Page 13
- TECEconnects: New architecture horizons**..... Page 14
- TECESpotlight: Digital innovations platform**..... Page 15
- TECEprofil: A pre-wall system turns 25**..... Page 16
- 4 **Hygiene flush: Excellent potable water hygiene**..... Page 17
- 5 **TECEone: New cold water variant**..... Page 18
- TECEfloor: Tacking sheet supplements full range**..... Page 20
- International business: TECESystem premiere in Lithuania**..... Page 21
- 6 **Digital information and service formats**..... Page 22

## Editorial

# A GOOD THING JUST GOT BETTER – FLUSHING TECHNOLOGY UPGRADE 2021

Dear Sir or Madam,  
Dear Readers,

Maintaining the tried and tested while at the same time creating added value in terms of function and assembly that is geared to everyday practice – this remains our passion, the “close to you” that we live and breathe.

We have always attached particular importance to “behind-the-wall” products. After all, they are trusted products in the bathroom and toilet that need to provide years of trouble-free service and, if the worst comes to the worst, must also be easy and practical to maintain and repair.

This year's innovations and this TECEnews are therefore focused on the latest innovations in our flushing technology: “Keeping everything simple!” – this was very important to us and is the guiding principle behind our work on the TECE toilet module with universal cistern and we incorporated your suggestions from the market into it.

Greater safety and efficiency in daily operation are more important than ever. And so it is with quite some pride that we are able to present you with a whole range of innovative functions and clever details that will make the installation of this universal cistern even more intuitive, faster and more reliable in future. And with everything, the same adage applies: Everything can be combined. The modular concept, i.e. the compatibility of our ranges throughout, remains our maxim for products that are both assembly and maintenance-friendly.

At the same time, we have also put a good deal of energy and motivation into updating our design products “in front of the wall”. The new surfaces and designs of the flush plates are the cherries on our 2021 innovation cocktail, so to speak. Well-known classics appear in a new look; and we have treated ourselves to a new collection that has been developed together with an internationally renowned designer and is offered for the first time with the innovative FENIX NTM® material surface for this area of application.

And that is by no means all. Other clever products and intelligent services await you. There is something for every one of our customers, for the trade, retailers, architects and planners.

I hope I have been able to arouse your curiosity.  
So please be sure to browse through and take a good look.



Hans-Joachim Sahlmann  
Managing Director



Hans-Joachim Sahlmann

# PROVEN TECHNOLOGY – EVEN BETTER IN HANDLING

In order to offer universality, regular improvements to the product are required in the constantly changing world of sanitation, heating and air-conditioning. That's why TECE has responded to suggestions from the market in the spirit of “close to you” and has now added practical upgrades to its toilet module with universal cistern, retaining proven features while creating added value in terms of function and installation.

04

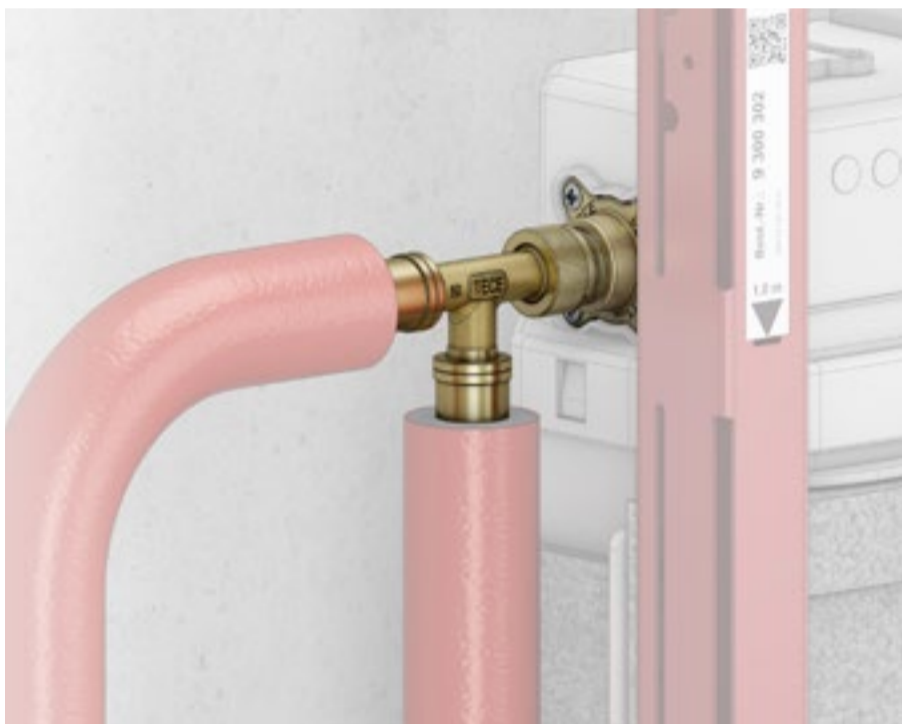

NEW

## Quick connection without sealing

Thanks to the new **water connection** with 1/2" outer thread, the universal cistern is connected to the mains in no time. It is compatible with commercially available quick adapters and there is no need for time-consuming sealing between the corner valve and the connection component. Quick adapters for the TECElogo and TECEflex pipe systems are available.

## Upgrade

- easy fit tool-free quick assembly for flush plates
- Quick adapter for water connection: no sealing, no errors

## Reliably proven

- Can be combined with all TECE flush plates
- Sealed tank doesn't have to be opened in shell construction
- 10-litre safety tank – for direct additional flushing (without waiting)
- Universal cistern for all applications and toilet ceramics
- Tested in accordance with DIN EN 14055





## Simplified flush plate assembly

Get there quicker: with **easy fit**, assembling the flush plate can be done without stress and in one go. This not only saves on nerves, but also around two thirds of the working time. You can find out exactly how it works on the next page.

Discover the new TECE Uni cistern:  
in our new function video at [www.tece.com](http://www.tece.com)  
or on the TECE YouTube channel.



easy fit

# THE NAME SAYS IT ALL

Thanks to the new easy fit mounting principle, attaching the flush plate to the improved TECEprofil toilet module with universal cistern is even easier and quicker than before, without the need for readjustment or measuring – the name says it all.



## That's how simple easy fit is

Insert the screws, push them through and tighten them with just a few turns – the attachment frame is already firmly seated on the splash guard of the universal cistern. Now simply insert the actuation rods and fix them in place with a 45 degree turn. Job done.

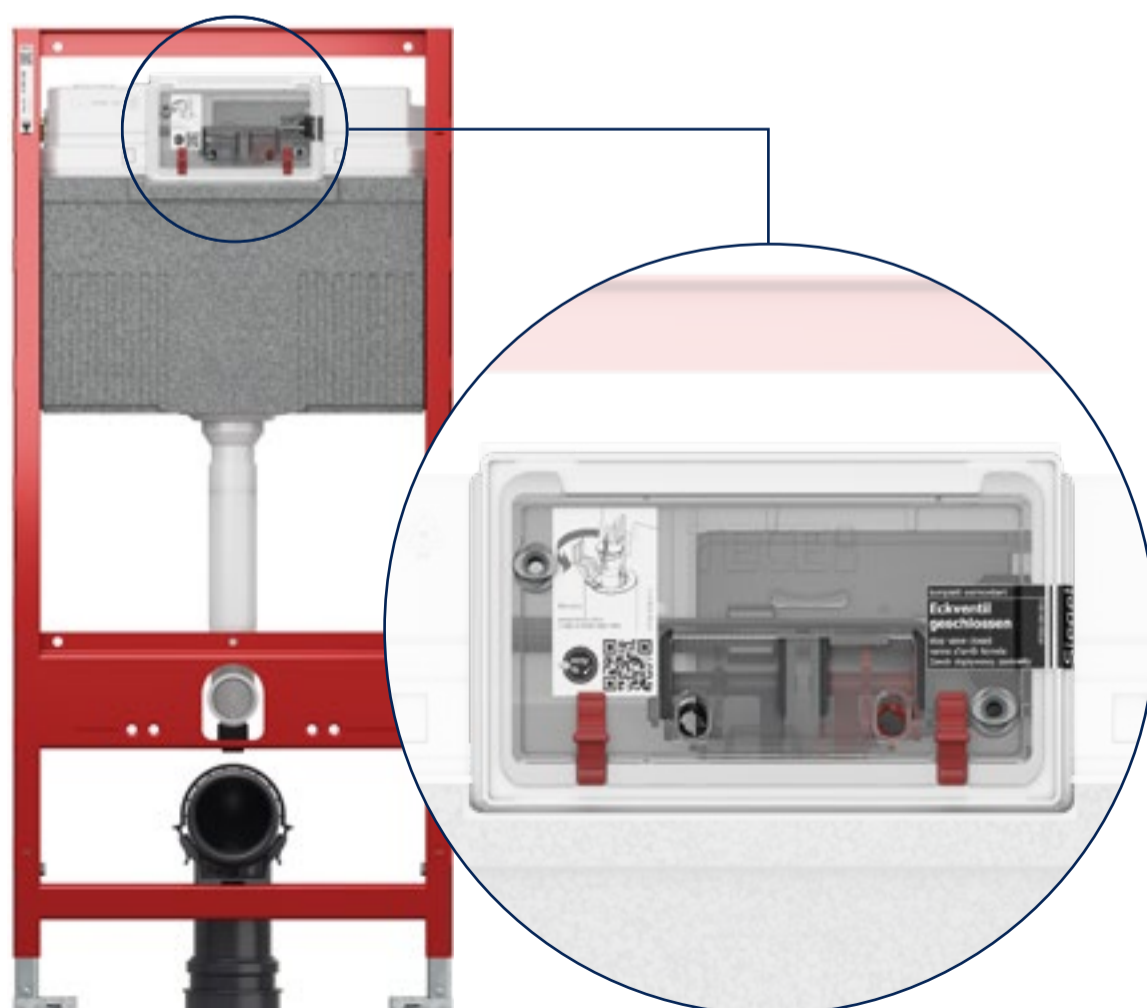
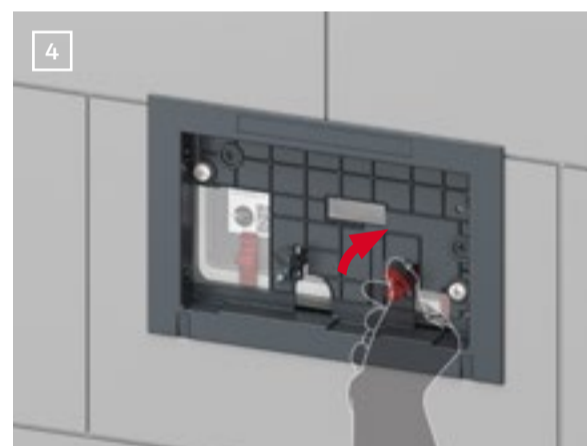
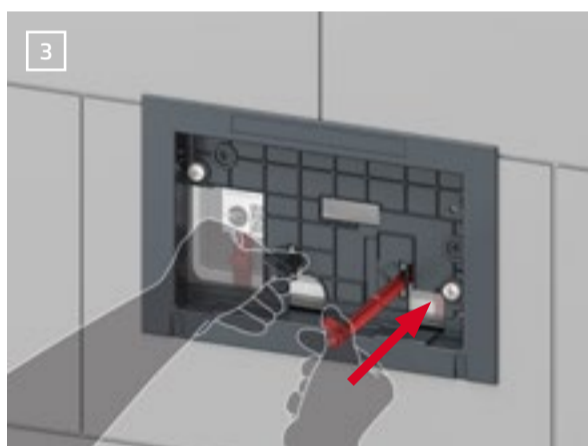
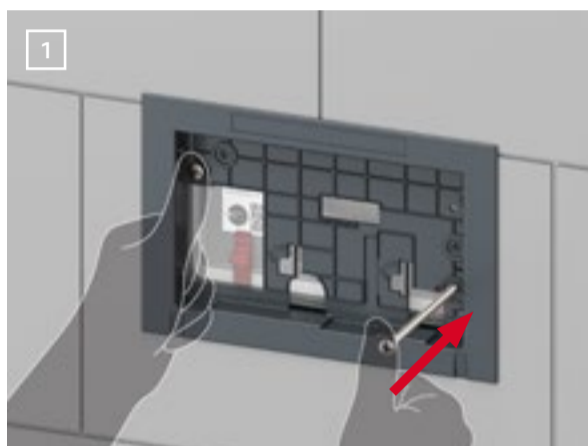

## Optimised splash guard

As part of the easy-fit upgrade, TECE has also optimised the splash guard: thanks to new insertion aids for the actuation rods, they fit even faster. The clamping screws have been replaced by clamping slides, meaning no additional tools are needed for fixing. To make it easier to attach electronic flush plates, the cable feed-through for the power supply has been enlarged. In addition, a continuous dirt deflector protects the cistern from dirt and grime.



“With these upgrades, we are responding to suggestions and direct discussions with the trade to make everyday working easier. And as ever, true to TECE tradition: full compatibility throughout the whole range.”

Andre Meiermann, Product Manager Sanitary Systems

## Everything fits – as it always does!

With TECE, every toilet flush plate fits every cistern. This means that when redesigning the bathroom, the TECE flush plate can be replaced without any problems and without running the risk of having to replace the cistern. This consistent compatibility is also maintained with easy fit - whatever the series, whatever the year. In concrete terms, this means that with easy fit, old flush plates from stock fit on new universal cisterns just as well as new flush plates fit on old TECE cisterns. To enable the customer to quickly access assembly information, the product database or spare parts, QR codes can now be found on the individual components such as the attachment frame, the splash guard and on the flush plate box, allowing direct access.

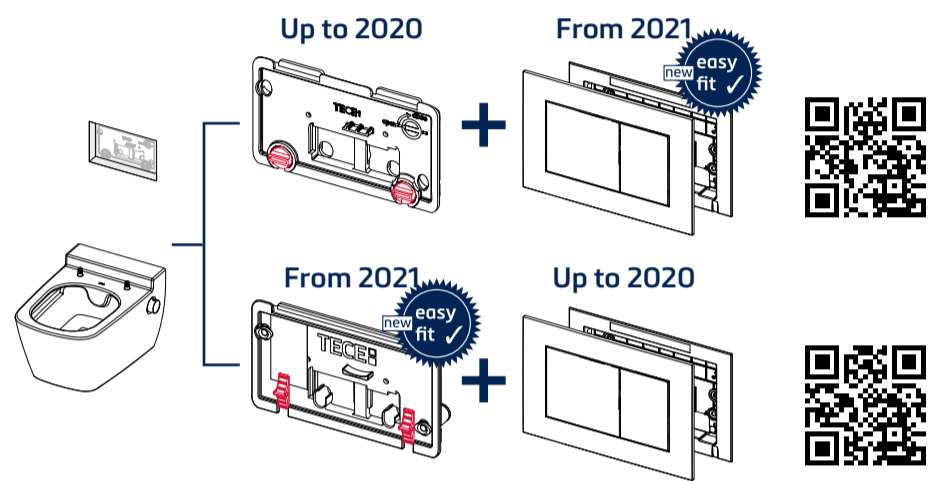

This is how assembly works with and without easy fit. Simply scan the QR code or take a look at our YouTube channel or [www.tece.de](http://www.tece.de).

Low installation height 750 millimetres

## PREPARED FOR THE LATEST TRENDS

NEW

The new improved TECEprofil toilet module with universal cistern will also be available in the particularly low installation height of 750 millimetres from autumn 2021. The background for this “reduction in size” are countertop washbasins, which are becoming increasingly popular in Germany, especially in the hotel industry. The new modular frame is 70 millimetres lower than the previous 820 millimetre cistern and therefore allows countertop washbasins to be installed at the correct height on half-height pre-wall installations.

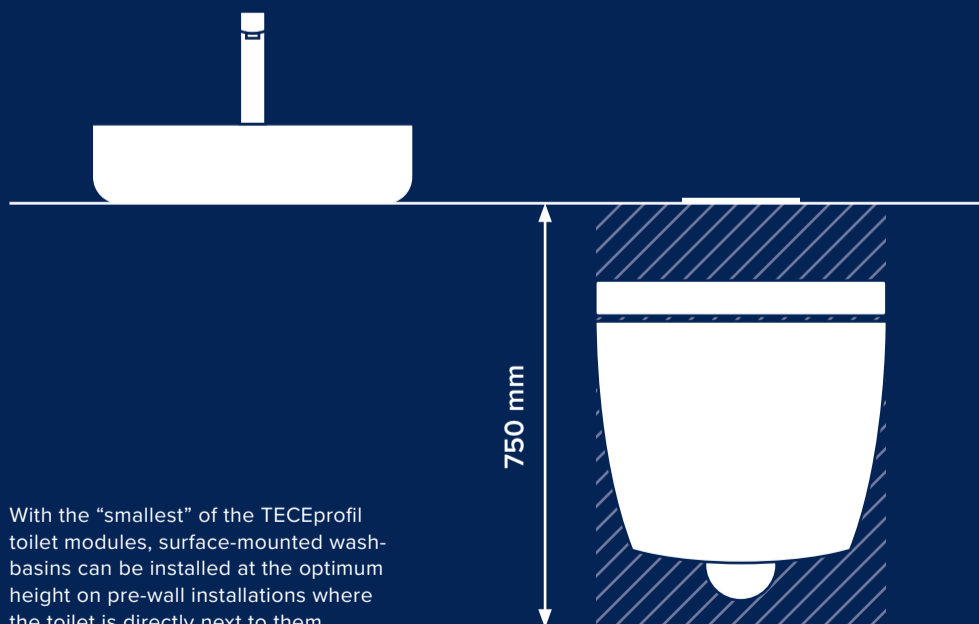

With the “smallest” of the TECEprofil toilet modules, surface-mounted washbasins can be installed at the optimum height on pre-wall installations where the toilet is directly next to them.

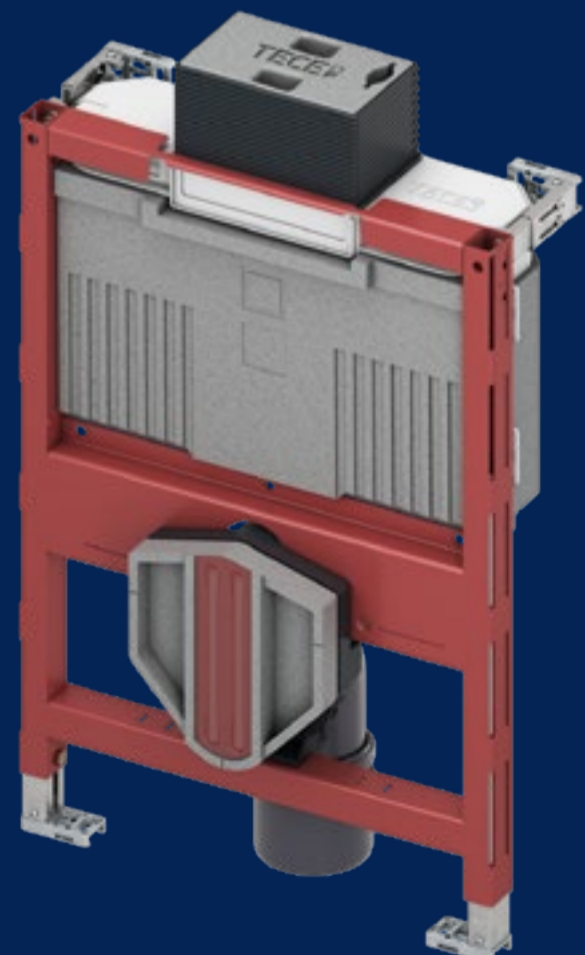



TECEvelvet

# DESIGN YOU CAN FEEL

Bathroom planners, architects, end customers ... It's worth everyone's while to take a closer look – and feel. With TECEvelvet, TECE has succeeded in expanding the range of toilet flush plates with an independent collection full of exciting facets. The internationally renowned designer Konstantin Grcic was commissioned for the new design, and TECE relies on the innovative FENIX NTM<sup>®</sup> material surface for the velvety feel in modern colours.

Bathroom users usually only consciously notice the toilet flush plate when they activate the release. The visual power of the plates as a graphic element in the bathroom and the role of physical touch is therefore often underestimated. Here, the flush plate is quite similar in nature to the door handle. The challenge for the designer was to further develop the design language of the flush plate in such a way that it is unmistakable without forcing itself too much into the consciousness. A tightrope walk that Grcic elegantly resolved by giving a new, clear geometry to the small and large flush volume plates.

“To design things that are essential and part of our daily routine in such a way that the unconscious is not disturbed: That was precisely the appeal of the design task with TECEvelvet.”

Konstantin Grcic



© Hugo Boss





## Magic Material

FENIX NTM® has an **extremely matt appearance** because its nanostructure scatters the light instead of reflecting it directly back to the observer. This has already inspired many architects and interior designers in furnishings and furniture as well as in kitchen design and now also creates an exclusive ambience in the bathroom. It feels pleasantly **velvety, soft and warm to the touch** and is almost reminiscent of textiles. At the same time, FENIX NTM® is robust, hygienic and easy to clean and has already proven this many times over in tough everyday kitchen use.

Fingerprints are prevented by the innovative acrylic material, as is the penetration of dust and water – **the surface always looks impeccable**. It is also resistant to scratches and abrasion as well as to acidic and household cleaners.

## Reduced installation height

TECEvelvet is set up a maximum of five millimetres in front of the wall. Flush-mounting is possible with an optionally available installation frame – only a filigree circumferential gap then visually separates it from its surroundings.

This is particularly effective when it is recessed into a wall cladding with FENIX NTM® in the same colour and material and, as it were, blends into it.



## Matching the urinal



TECE also equips its TECEfilo sensor-controlled urinal release with FENIX NTM® in the same six colours. This allows aesthetically pleasing ambiances to be created in semi-public spaces that speak a uniform language of material and form.

## Carte blanche for elegant bathroom design

TECEvelvet is available in six colour shades, allowing perfect harmony in any bathroom ambience.

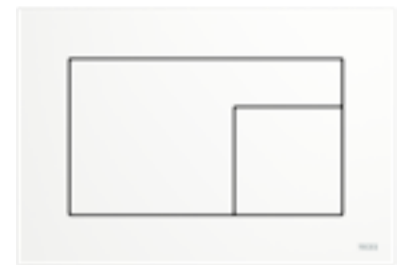

Bianco Kos / White

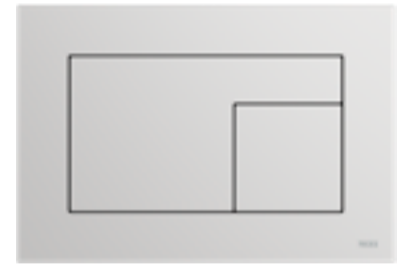

Grigio Efeso / Stone grey



Grigio Londra / Anthracite



Nero Ingo / Black

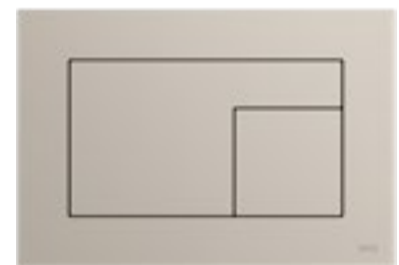

Beige Arizona / Greige

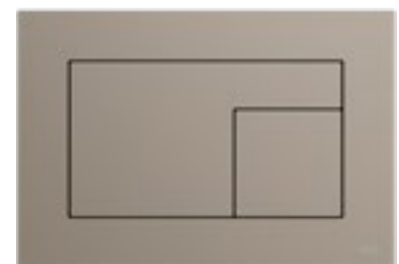

Castoro Ottawa / Beige/brown

TECEloop modular system with new surfaces

# FRESH IMPETUS FOR THE ORIGINAL

For many years, TECEloop flush plates have been delighting customers with their wide range and architecturally clear shape. TECE is now giving this design classic a comprehensive makeover with up-to-date colours and authentic materials.

Within the extensive TECEloop flush plate range for toilets and urinals, the modular system offers a unique system that allows customers to put together their own individual toilet flush plates. In order to meet even the highest architectural demands, TECE is now expanding the range with three covers made of concrete, oak wood and marble. With the designer flush plate made of real slate, which has already been successfully placed on the market, there are now four variations made of natural materials to choose from for upmarket bathroom construction. All the covers in the modular system can be individually combined with coloured and metallic push-buttons.

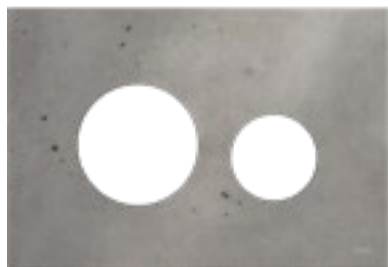

TECEloop concrete cover

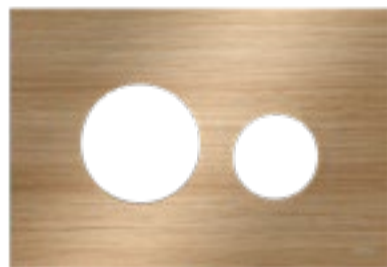

TECEloop oak cover



TECEloop marble cover



TECEloop slate cover

With the **TECEloop modular system**, cover and buttons can be combined individually – for an all-round individual bathroom design.



Buttons

+



Cover

=



In the past, concrete was supposed to disappear under the plaster, but today it is recognised as a design element. With the TECEloop cover made of real concrete, this can now be achieved throughout the bathroom.

The new covers will be available from April 2021.



TECE is expanding the TECEloop modular system with three new glass covers – shown here in evening blue.

## New glass covers for the TECEloop modular system FRESH COLOURS FOR THE CLASSIC

The colour researcher, designer, book author and colour artist Prof. Axel Venn advises companies worldwide on product design, colour marketing and an authentic colour policy. He supports TECE with his expertise in developing new surfaces and colours. One result of this collaboration are the three new colours for the TECEloop modular system: evening blue, titanium and light beige. The deep, dark evening blue creates sensual, elegant accents, titanium is an all-rounder for almost any environment thanks to its warm grey, and light beige finally offers light bathrooms a nice feel-good alternative to cool white with its pleasantly soft tone.



TECEloop glass cover  
Evening blue



TECEloop glass cover  
Titanium



TECEloop glass cover  
Light beige

The three new glass covers will be available from April 2021.

## TECEloop plastic DESIGN FOR ALL

There are also interesting innovations for the robust and easy-care plastic version of TECEloop:

The TECEloop plastic plates have been given a technical update. They are now equipped with flat push-buttons and are harmoniously flush with the cover, as has long been the case with the modular system and the prefabricated sets with glass covers. In combination with the special installation frame, this allows for a completely flush-mounted wall installation.

As part of a comprehensive style update (see page 12), TECEloop plastic is now also available in black and white matte.



TECEloop plastic with new flush-mounted push-buttons, here in the trend colours matte black and matte white.

Flush-mounted push-buttons for the TECEloop sets made of plastic and the new trend colours will be available from the second quarter of 2021.

## TECE flush plates

# ELEGANCE IN MATTE

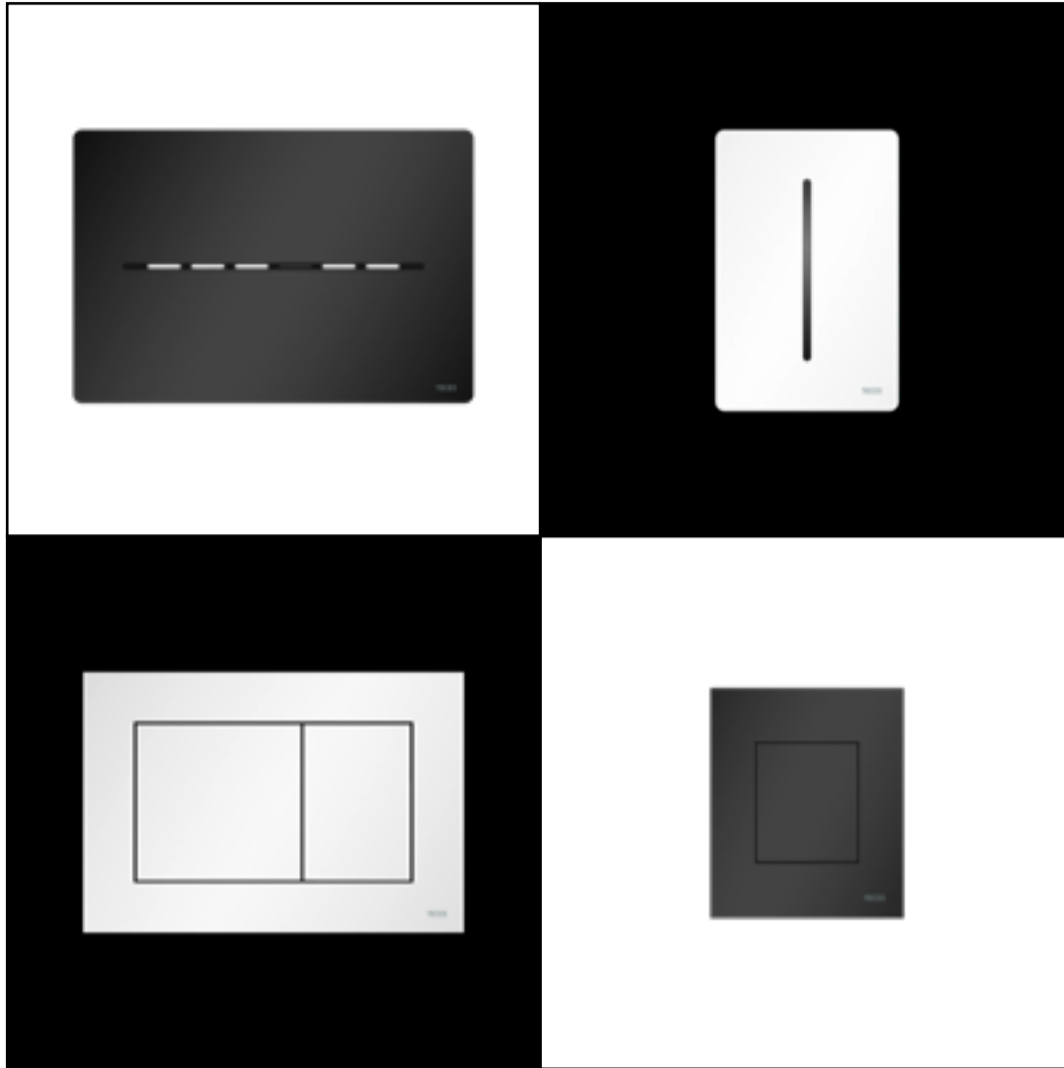

The TECE flush plate collections have been expanded with the trend colours black and white matte. Supplemented here as an example: TECESolid toilet electronics (top left), TECEfilo solid urinal electronics (top right), TECEnow toilet flush plate (bottom left), TECEnow urinal flush plate (bottom right).

Black and white are the timeless classics in the bathroom, appreciated for their simple elegance and because they always work. Now matte surfaces have also made their entrance. In addition to matte white, matte black is setting the tone here. TECE has been alert to this trend and has given its entire flush plate range a style update. Design for every taste and all levels of furnishing.

The new surfaces are available in black and white matte for the following flush plates:

### Toilet flush plates

- TECESquare metal
- TECEloop plastic
- TECEnow
- TECESolid
- TECESolid toilet electronics

### Urinal flush plates

- TECESquare metal
- TECEnow
- TECESolid
- TECEfilo-Solid urinal electronics

**The trend update for the flush plate range will be available from May 2021.**

## TECEnow in matte black

# SMART, HIGH-QUALITY, FLAT

If quality accents and exciting contrasts are to be achieved in the bathroom, then matte black surfaces are currently the way to go. They look individual, elegant and cool – and are guaranteed never to go out of fashion. Especially as a contrasting colour to natural stone tiles, wood or in combination with metallic surfaces, matte black makes a real statement in the bathroom. This fascinating colour option is now also available for TECEnow. The matte black surface elegantly emphasises the functional, plain design, the defined edges and the flat design of the plastic flush plates for the toilet.

But not only the look visualises quality – the feel, too, is refined: the full, mechanical haptics of the flush buttons with rubber buffers add to the overall impression of high quality. The plate also offers the tried-and-tested dual-flush system with small and large flush volume, and can also be installed flush-mounted. With the matte black TECEnow, the trade and planners can offer their customers a mature solution that looks like an elegant designer piece but was designed for the plastic segment: refined for everyone.

**The TECEnow in matte black is available now.**



Matte is on trend and black always goes: The TECEnow toilet flush plate combines both.

## TECEdrainprofile with PVD coating

# NOW ALSO IN ELEGANT BLACK

In line with the style update for the flush plates, TECE has now extended the range of TECEdrainprofile shower profiles to include the "Brushed black" version. The new deep black surface of the shower profile now offers perfectly coordinated design options with fittings and flush plates.

The PVD-finished surface is extremely hard-wearing, which is particularly important for the walk-on areas of the shower profile and the increased mechanical loads that can occur here. TECEdrainprofile is also available in the PVD variants Gold Optic, Red Gold and Black Chrome, each with a brushed or polished surface.

**TECEdrainprofile will be available in "Brushed black" from June 2021.**

TECEdrainprofile is now also available in "Brushed black". Customers can use this trend colour to great effect throughout the bathroom.



## TECEdrainprofile up to 1600 mm

# SHOWERS IN 3XL FORMAT

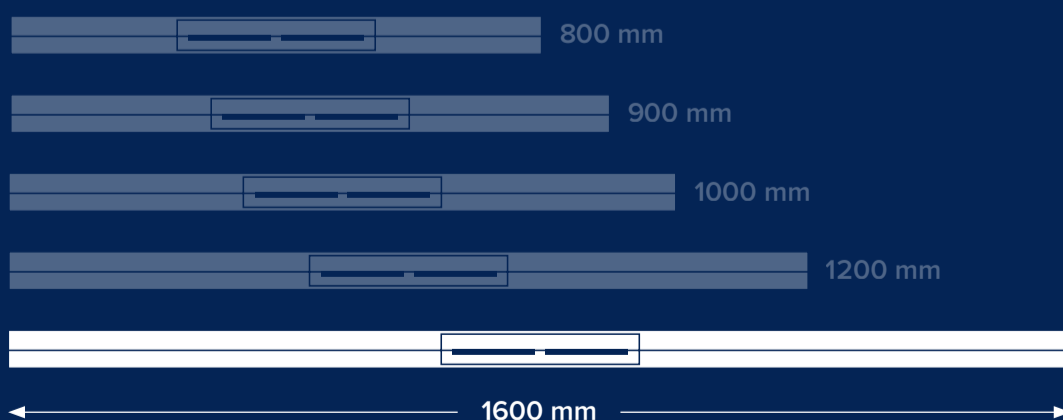

There is a demand for oversized floor-level showers in both design bathrooms and barrier-free bathrooms. The 1600 mm TECEdrainprofile meets these demands and as a result supplements the shower profile range in the 800 to 1200 mm length sector. The profiles can be easily shortened with a hand saw for an exact recessed installation. The new product is also fully compatible with the accessories of the extensive TECEdrainprofile modular system. For even larger floor-level showers, we recommend installing several shower profiles.



Guest speaker Sven Göth, business futurist, during his "Skills for the 21st century" presentation.



Michael Schuster, TECE, at the corona-compliant introductory moderation of a talk.

TECEconnects

# OPENING HORIZONS, GENERATING IDEAS AND NETWORKING PEOPLE

Direct proximity to the customer as well as a lived culture of dialogue and questioning make up TECE's DNA – and give rise to ideas such as TECEconnects. The new interactive digital format networks clients and designers from the architecture, construction and property sectors and is an incubator for ideas. The pilot event, at which guest speakers shone light on the topic of digital[+]analogue from different angles, was a complete success and even exceeded expectations of the format.

The topic of the evening was digitalisation, which is on the verge of revolutionising the construction industry as well. Seven renowned speakers from the fields of architecture and planning highlighted the opportunities offered by digital processes and provided suggestions on how they can be integrated into the value chain of construction and planning processes. The moderated event took place at the AIT Architektursalon in Hamburg, in a mixture of virtual and on-site presence of the speakers. "For an online event, the turnout was pleasantly high," says Michael Schuster, Key Account Manager Architecture, with a view to the number of

participants at the TECEconnects premiere - and a touch of understatement. Over 160 interested parties took part in the digital event, a large proportion of them over the full stream length of 3.5 hours. This speaks both for the high information content of the symposium and for the entertaining presentation – online attention spans are usually rather short as the option of leaving is always just a mouse click away.

In future, TECEconnects will be held twice a year, the next one will be on 20 April 2021. Once again, the focus will be on "perspectives" in architecture and the construction industry, a

deliberately open topic that arouses curiosity and invites people to take a different perspective and come away with new impulses.

TECEconnects can be found under the following link:  
[www.tececonnects.com](http://www.tececonnects.com)

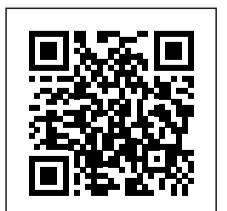

Digital innovations platform

# CLEAR THE STAGE FOR TECE SPOTLIGHT

Lights out - spotlight on! TECE is now presenting its new products on its own new stage. The digital, interactive TECEspotlight platform shines its spotlight on the highlights of the current new products and serves up all the relevant information at a glance in a user-friendly way.

With TECEspotlight, everything you need to know about the company's product highlights can be called up directly and without further ado – no important information is left out. Plumbers, planners, architects and end customers are presented with multimedia content in a clear and easy-to-navigate structure.

Additional functional videos and separate download areas with photos, tender texts, technical data, etc. further enrich the information on the products presented. If users have individual questions, they can contact TECE directly via a contact button.

TECEspotlight provides targeted information on new products and therefore offers a focused alternative to the TECE website with its extensive range of information and services. This new platform is designed for the long term and for further expansion, but also offers an important alternative to product presentations in the tried and tested trade fair formats. It's worth taking a regular look at the platform, as it will continue to be updated with further product innovations during the year.



Click here to go directly to  
TECEspotlight:  
[spotlight.tece.com](https://spotlight.tece.com)

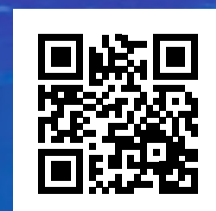

## TECEprofil

# FLEXIBLE BATHROOM DESIGN FOR OVER 25 YEARS

As early as 1995, TECE launched a pre-wall system on the market that revolutionised bathroom construction from that moment on: TECEprofil has established itself as one of the most reliable systems for reducing interfaces and fulfilling customer wishes when designing individual bathroom dreams.

The pre-wall system, which has now been used millions of times, has always consisted of just three basic components: section tube, corner joint and angle bracket. The success of this intelligent system is based on the simple and flexible handling of these universal basic components in combination with the matching sanitary modules. In those days, installation systems mainly consisted of simple assembly elements for brick-wall construction. With TECEprofil, a quick and easy-to-install alternative emerged onto the market as a pioneer for pre-wall construction.

After its market launch, unimagined design freedom was opened up in the bathroom: half-height and free-standing walls with additional niches and storage areas, on which the toilet and washstand are statically secured. With TECEprofil, a new sense of space emerged, which contributed to the bathroom being transformed into a living space. Since then, TECEprofil has reliably mastered all the changes to standards and technical challenges. For quick and precise planning, TECE also offers the clear, easy-to-use and free-of-charge TECESmartwall software.



Free choice of space for toilet, washstand, shower and niches for shelves: the pre-wall system lets you implement individual design possibilities in a straightforward way.



Meeting customer requirements with just three components: angle bracket, section tube and corner joint.

## TECEprofil magnetic holder

# “THIRD HAND” FACILITATES ONE-MAN INSTALLATION

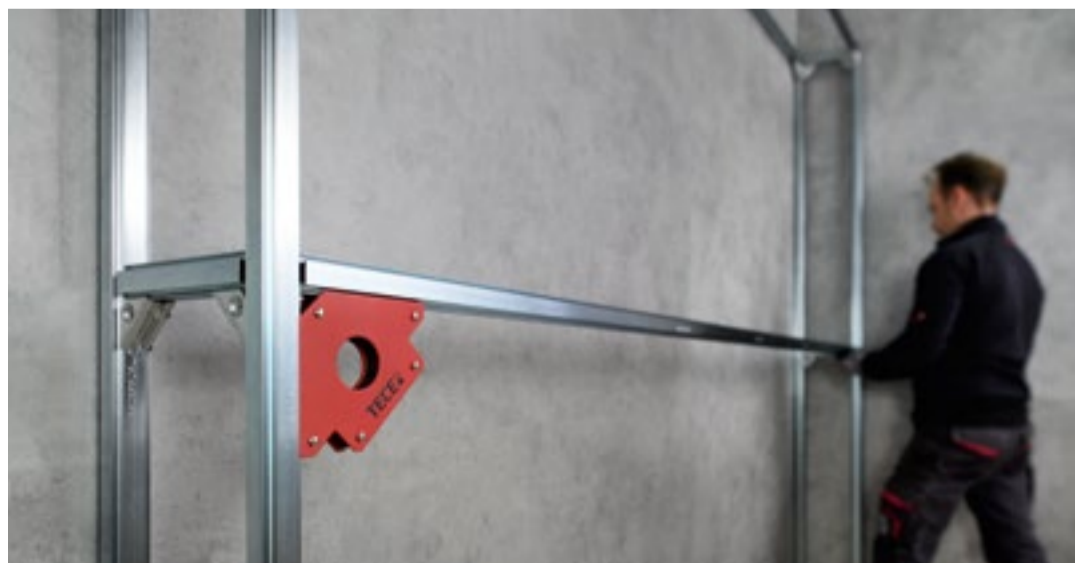

Even in small bathrooms with a small floor area, a pre-wall installation can be two metres or wider. In order to make the one-man installation of long section tubes in the horizontal position completely relaxed and to avoid the need for acrobatics, TECE now has a small, practical helper that can be used as a “third hand”: while the new TECEprofil magnetic holder keeps the horizontal section tube level on one side, it is attached to the vertical tube on the other side with the triangular connector. The magnetic holder is then also replaced with a corner joint and the profile sits as it should: robust, stable and torsion-resistant.

The “helping hand” from the tool box: with the TECEprofil magnetic holder, long section tubes can be conveniently installed on your own.



TECEprofil toilet module with integrated hygiene flush

# HYGIENE OUT OF THE BOX? EXCELLENT!

Stagnation, legionella, legal problems – not with potable water hygiene solutions from TECE! TECE is the first sanitary technology supplier to integrate the hygiene flush unit into the cistern. The German Design Award-winning product is now also available as a cold-water-only variant.

## No additional inspection opening in the bathroom

The flushing unit is integrated into the cistern and can be easily accessed after removing the flush plate. Two electronically controlled valves, which can be programmed via app, ensure a regular water exchange of the cold and hot water installation and document every hygiene flush with the log function. And all this without an additional inspection opening. This product concept earned the innovative TECE solution the German Design Award 2021, “Winner” in the “Excellent Product Design – Bath and Wellness” category.

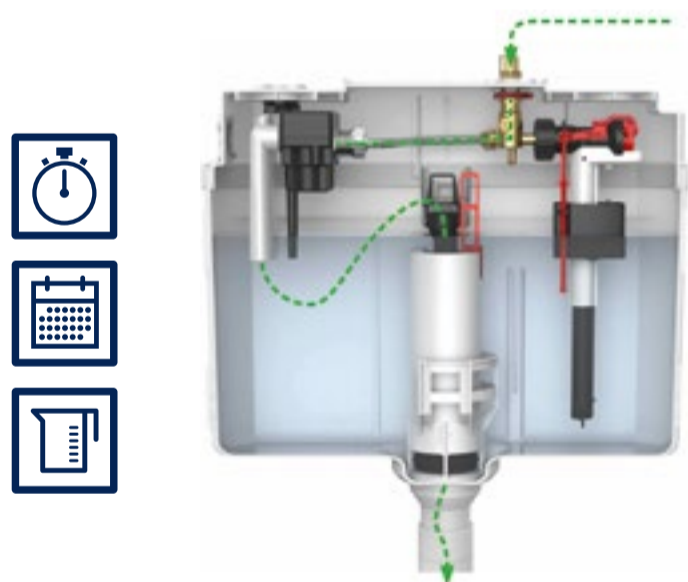

## New special solution for schools & other buildings

TECE is now launching the innovative product as a cold-water-only variant especially for cold-water installations, such as those commonly found in schools or the catering trade. This station also offers the full range of functions: programmability of the exact flush volumes, application-specific “Interval” and “Weekday” flush programs, integration into the BMS. The log function is an essential element here, as it provides the operator with proof of the correct operation of the potable water system.

## TECESolid toilet electronics

# JUST ADD HYGIENE

With the battery version of the TECESolid toilet electronics, a hygiene flushing function can also be retrofitted in cold water networks. In this case, the power supply is provided by a long-life and waterproof battery pack. The flush plate fits on every TECE universal cistern and, with its robust stainless steel plate, is also suitable for public areas. With this retrofit solution, hygiene flush intervals of 24, 56, 72, 168 or 336 hours can be selected. Programming and logging is also carried out here via app. TECESolid for urinals is also available with hygiene flush.



Touch-free activation and built-in potable water hygiene are highly topical selling points for the TECESolid flush plate.

**TECEone**

# PURE SHOWER TOILET FRESHNESS

With a new shower toilet for cold water connection, TECE is appealing to shower toilet purists who want to benefit from the health advantages of cleaning with fresh, cold water from the tap. This completes the TECEone toilet family and allows flats and buildings to be fitted out in one design and with different levels of furnishing.

Many cultures prefer water to toilet paper, as water is far superior to the cleaning effect of paper. All the more so when proctological complaints or sensitive skin require gentle, thorough care. In these cases, doctors usually recommend cleaning with cold water fresh from the tap, as it has a beneficial effect on blood circulation and irritated skin areas.

But the new TECEone is also an option when it is not possible for a hot water line to be connected to the toilet – for example, in bathroom renovations on a small budget or in guest bathrooms. This is because it can be retrofitted to any cistern without the need for an additional hot water line.

Like all TECEone models, it comes in installation-friendly packaging, which serves as a back-friendly transport aid and spacer. The ceramic can be installed effortlessly using the tried-and-tested TECE fastening technology. Due to the system, there are no small components or screws that might fall inside during installation, and the necessary tools can be found on every construction site.

## Safety according to standards

The safety device integrated in the TECEone to protect the potable water meets the requirements of DIN EN 1717 – TECEone can therefore be connected directly to the cold water pipe. The ceramics and toilet seat also both meet the relevant standards DIN EN 997 and DIN 19516.

## Three toilets, one DNA

As TECEone is designed as a family of toilets, the new model with cold water shower function is identical to its siblings in many details: the same familiar, rimless design, the wobble-free, pre-adjusted seat, the same technical features, the same ease of installation and maintenance. The subtle difference is only noticeable in the controls on the side.

Like the hot-water model, the cold-water variant draws up to 5 litres of fresh water per minute directly from the pipe and makes it available via the hydraulically extending shower arm. Thanks to the high and soft volume flow, the shower experience is thermally comfortable even with cool water. The water strength is intuitively regulated via the rotary wheel on the side.

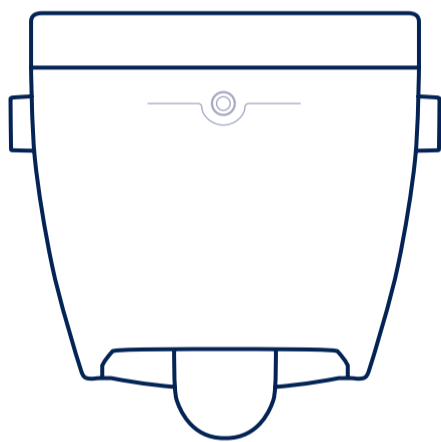

Full shower-toilet comfort with the TECEone hot water version. It is conveniently controlled via the side dials for water strength and temperature.

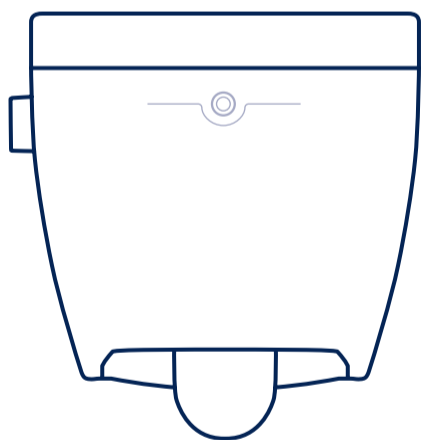

**NEW**

Cleaning with cold water is effective and sometimes even medically recommended for intimate hygiene. The new cold-water TECEone is the perfect product for this.

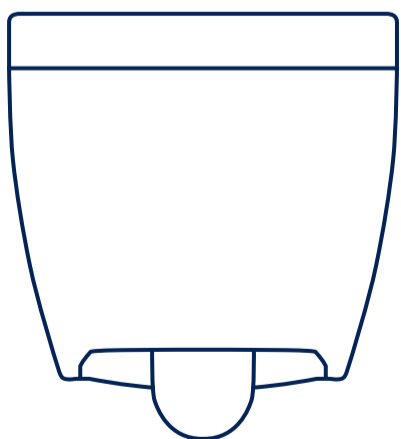

The same classically elegant TECEone design, but without the shower function. Ideal for equipping all bathrooms from the guest toilet to the master bathroom in one toilet design.

TECEone with cold water shower function is available from stock.

TECEone

## ADVISE CUSTOMERS, AVOID ANNOYANCE

More than eight million hits on "shower toilet" in the search engine and a growing crowd of enthusiastic users – there's a high chance that your bathroom customer will come across the topic sooner or later! That's why you should explain shower toilets to your customer in the course of a good consultation. Ideally, this should be done before the bathroom is completely installed, otherwise annoyance and disappointment are inevitable: at the latest when a neighbour or brother-in-law is brimming with enthusiasm about their new shower toilet and you haven't even pointed out the possibility to your customer, even though they have invested 20,000 Euros or more.

Of course, advisory services in the trade are expensive and time is usually so limited that you cannot spend half an hour advising every customer on shower toilets unless they ask. But at least draw attention to the trend and point out where they can get information. Your customer will thank you for it!

To support you, TECE provides a practical information card with a link to a special homepage, which you can give the client during the consultation. The website is precisely tailored to the needs and questions of end customers with no prior knowledge and relieves you of the time-consuming task of providing advice. The website explains TECEone sympathetically and plainly in text, pictures and video, enhanced with customer testimonials. The advantages for you: you have fulfilled your obligation to provide information in the technical consultation, avoided subsequent annoyance and, in the best case scenario, achieved a sale with a good profit margin, with a product that you can install and maintain yourself without any problems.



All information on TECEone at a glance:



## TECEfloor tacking sheet

# NO MORE JIGSAW PUZZLES WHEN IT COMES TO INSULATING

Insulating underfloor heating systems can be a tedious and lengthy affair, which can sometimes degenerate into a real jigsaw puzzle when the underfloor heating system has to be fitted in between electrical cables that have already been laid. Of course, this also has to take heat and sound insulation into account. To save time and nerves, there is now a clever addition to the range, the TECEfloor Flat2 tacking sheet, which is just two millimetres thick and provides a remedy in this scenario. The new polypropylene hollow-chamber tile can be easily laid on different insulation layers on site. This means the insulation work can be carried out independently of the installation of the underfloor heating system. Good for the installer, who saves a time-consuming work step.

The latest child from the TECEfloor family has even more advantages: the new tacking sheet is supplied in accordion-shaped continuous lengths folded to pallet size (1.2 x 48 metres). This saves on storage costs and transport volumes. The folded sheet can be laid out over the entire length of the room so there are no joints. The sheets only need to be glued together at the sides.

The new TECEfloor tacking sheet is now available.



The new TECEfloor tacking sheet can be laid on different types of insulation and attached to the insulation with fixing hooks if required (for example in the room corners).

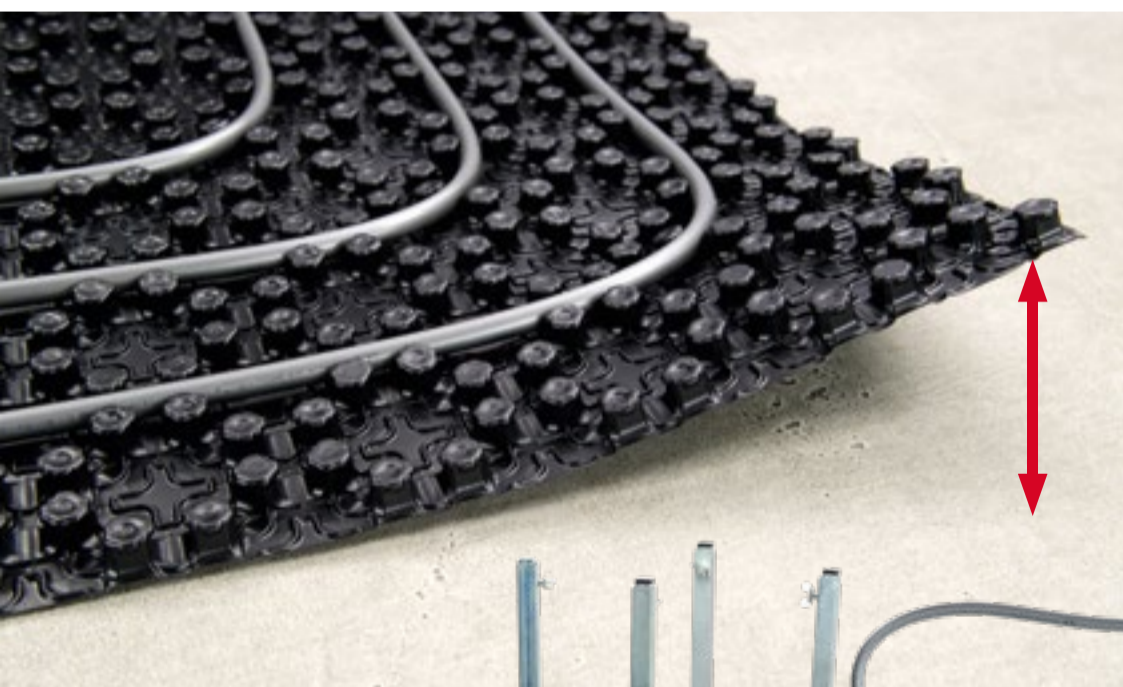

## TECEfloor aluminium multilayer pipe THE PIPE THAT WORKS WITH YOU

Anyone who has ever installed underfloor heating knows how stubborn heating pipes can be. They tend to jump off the reel when you open the roll. And when laid on the surface, the twist in the pipe pulls up the corners of the underfloor heating.

Not so with the aluminium multilayer pipe specially developed for TECEfloor: thanks to its soft core, the pipe is extremely easy to handle and can be laid comfortably. It can be unrolled smoothly and without twisting and, once laid, remains flat and in shape – even in combination with thin substrate materials and light insulation over a large area.



As soft as butter and yet dimensionally stable – once installed, it stays that way. The special TECEfloor aluminium multilayer pipe DIM 16 x 2.



The bathrooms of the Hilton Garden Inn Hotel were completed quickly and efficiently with prefabricated TECESystem sanitary walls.

## International business

# TECESystem PREMIERE IN LITHUANIA

21

Vilnius, the capital of Lithuania, is famous for its baroque architecture and medieval old town. But naturally, time has not stood still here either. To speed up the construction of the Hilton Garden Inn Hotel, prefabricated TECESystem sanitary walls were used for the first time in Lithuania.

The 7,000 square metre Hilton Garden Inn is not only the first 4-star hotel in Lithuania, it is also the first Lithuanian construction project in which industrially prefabricated sanitary walls have been used to optimise the construction process. These TECESystem walls are specially tailored to the installation conditions of the 164 hotel bathrooms and completely prefabricated for the areas of potable water, heating, waste water and ventilation ex works.

In this case, prefabrication took only two weeks and delivery to the construction site was just in time. Aurimas Valatka, Technical Advisor TECE Baltics, outlines the advantages of TECESystem: "TECESystem not only facilitated the construction of the hotel, but also significantly accelerated it. Building the pre-wall constructions on site would certainly have taken ten times longer."

The prefabricated sanitary walls were set up according to their labeling at their designated locations and attached to the building structure with sound-proofing elements. Finally, the pipelines were connected to the networks. Step by step, the individual supply lines for the hotel rooms were installed on time and in a time-saving manner.



The Hilton Garden Inn Hotel project in Vilnius was the first time that prefabricated TECESystem sanitary walls had been used in Lithuania to optimise the construction process of a project of this size.

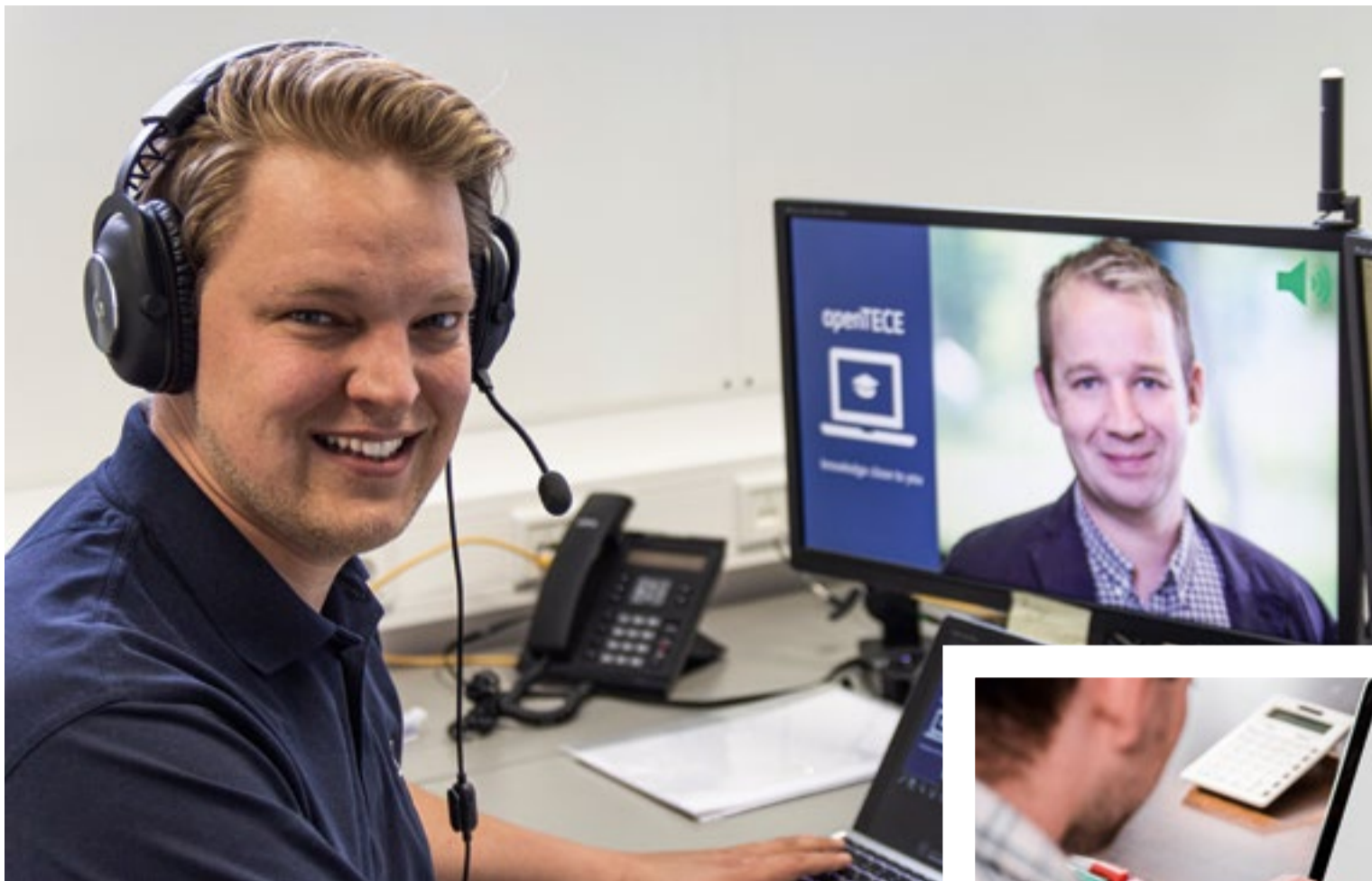

Hendrik Arndt and the openTECE team guide participants from the sanitary, heating and air-conditioning sector as well as building services planners, representatives of the housing industry and architects through the online courses, offering up-to-date and practical information from the sanitary, heating and air-conditioning world directly to their desktops at home.



## Digital services – openTECE

# PROFESSIONAL DEVELOPMENT FROM HOME

Under the name “openTECE - knowledge close to you”, TECE is supplementing its range of digital services with online-based e-learning courses for professional development. Here, specialists from the sanitary, heating and air-conditioning industry, building services planners, representatives of the housing industry and architects find topics from the extensive TECEacademy seminar range prepared for the Internet and at home – outside of the classroom.

Since the beginning of 2020, TECE has been offering this digital service, which has now become a fixed and indispensable pillar of our training offering. As in the classroom training courses, the agenda includes a wide range of information about the company, its products and services, which is aimed at sanitary, heating and air-conditioning professionals and increasingly also at experts from the architectural field. In the 45 to 60 minute courses, the number of participants is limited to small groups,

which allows the openTECE team to respond individually to questions from the participants.

Professional development opportunities such as this – whether by digital or “analogue” means - offer professionals the chance to stay regularly up to date, which is essential for professional success in an ever-evolving industry, be it technical, normative or legal. All the information on the openTECE offer is summarised at [www.tece.com/de/academy](http://www.tece.com/de/academy). Interested parties

can also find the dates via this link and register directly for the various webinars.

openTECE can be found under the following link:  
[tece.com/de/academy](http://tece.com/de/academy)

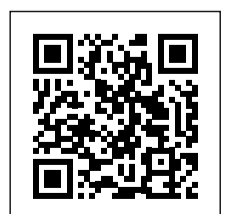

# FOR SERVICE OPERATIONS: FAST HELP DIGITALLY

Close to you – without being on site? TECE has a solution for this too! For service calls, the smart, video-based remote diagnosis quickly supports the installer “live on site”, providing virtual assistance – all you need is a smartphone or tablet.

Virtual service, direct and surprisingly simple. Wherever there is a service case and quick, uncomplicated help is needed, TECE remote diagnostics provide a valuable service. The TECE specialist contacts the installer “live” via the smartphone camera, thereby obtaining an overview of the service case “from a distance”. Help arrives immediately: to resolve the problem, TECE support marks the relevant points with a virtual pointer, thereby providing the installer with a quick reference on the product. If necessary, screenshots can also be exchanged or the assembly instructions displayed. Valuable waiting time is saved, the issue is quickly resolved and

unnecessary duplicated visits are avoided. The environment also benefits, because the digital TECE remote diagnostic service saves unnecessary trips to and from the site.

This new service has completed its test phase and customers are impressed: “Without the mobile phone diagnosis, it would not have been possible to continue work on the bathroom construction site for a few days. This saved us time and the customer was thrilled,” says Hauke Matzen, service technician at Industrievertretung Kremers.

To use the remote diagnosis service and get virtual help from the TECE specialists directly on site, all you need are bandwidths from 3G and a browser – an app does not have to be installed separately. This is also worthwhile in more complex situations. In these cases, remote diagnostics facilitate the introduction of further measures.

**Tested in Germany and soon available throughout Europe.**

## STANDARD CUSTOMER SERVICE



## SERVICE WITH REMOTE DIAGNOSIS

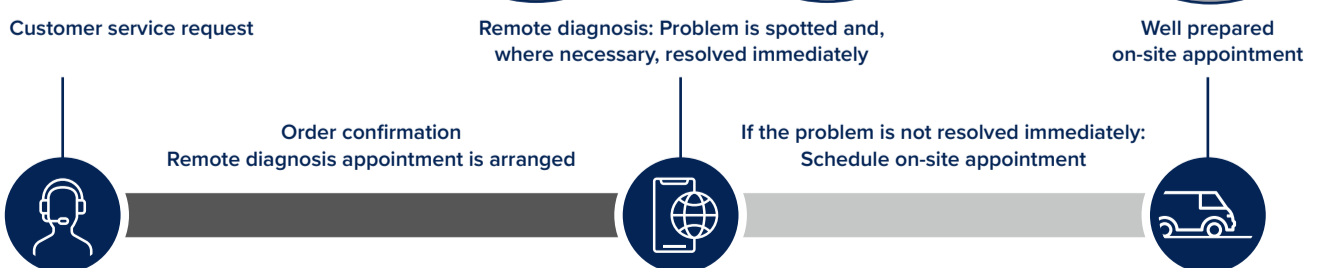

TECE brochures

# ALL YOUR INTERESTS

Detailed information on the latest products from TECEnews and the existing range can be found in our brochures, which you can download from [www.tece.de](http://www.tece.de) or request in printed form.



TECE universal cistern

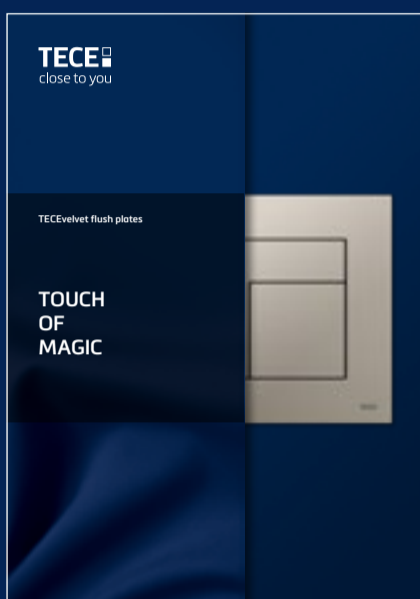

TECEvelvet toilet flush plate

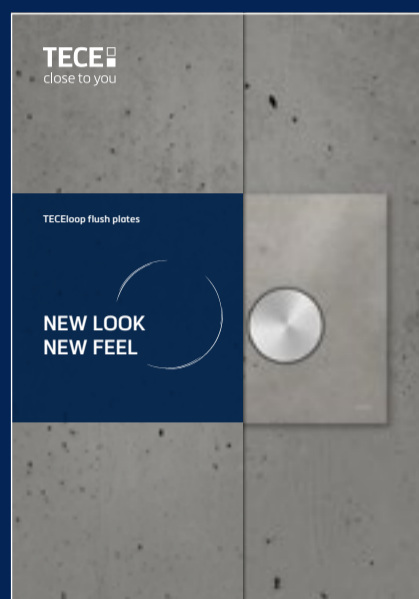

TECEloop toilet flush plate

Here you can find digital information on the latest products from TECE:

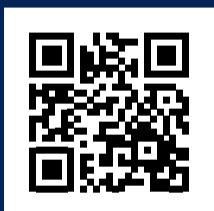

At **TECEspotlight** you will find focused, comprehensive information on the TECE highlight products of 2021.

[spotlight.tece.com](http://spotlight.tece.com)

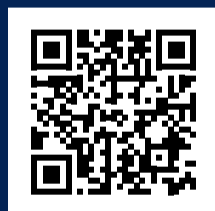

TECE will also be represented with its highlight products at this year's **ISH DIGITAL**.

[tece.click/ish2021-en](http://tece.click/ish2021-en)

TECE GmbH  
T +49 25 72/9 28-999  
[international-business@tece.com](mailto:international-business@tece.com)  
[www.tece.com](http://www.tece.com)

**TECE**  
close to you