

Installation walls

TECEprofil –
CREATIVE TO
DESIGN, SIMPLE
TO BUILD





“Pre-wall systems let me work more independently from other trades, allowing me to take control of the construction process. I can also lay the pipes and no longer have to cut any slots into the brickwork. After all, that can often be structurally tricky, too.”



TAKING CONTROL OF THE CONSTRUCTION PROCESS. THAT'S EASY WITH PRE-WALL TECHNOLOGY.

All demanding trades come together in the bathroom. And it is precisely here in the tightest of spaces that coordination with other trades must function down to the smallest detail. For more than 20 years, TECEprofil has offered the best basis for reducing interfaces and fulfilling customers' wishes. The pre-wall technology lets you implement different room layouts and comply with standards and regulations. Simply and safely.

ALL FROM ONE SOURCE. ADVANTAGE: PRE-WALL!

A universal support frame for every bathroom situation, combined with fully pre-assembled sanitary modules for every application. That's reliability and flexibility in the system.

Urinal modules for manual or electronic flush systems.

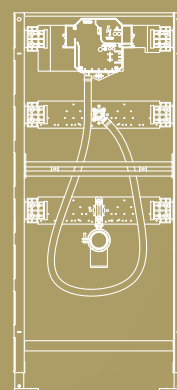

Washstand modules in various heights, from a module with a water meter connection unit to modules with a flush-mounted or wall-mounted odour trap to solutions for sinks.

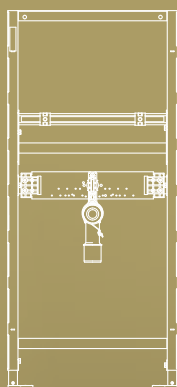

Toilet modules in various versions: including a Geronto module, a module specifically for nurseries and a module for shower toilets.

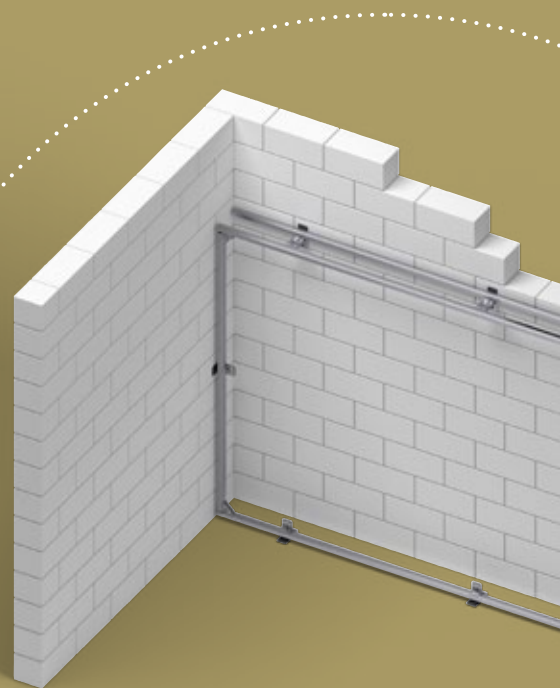
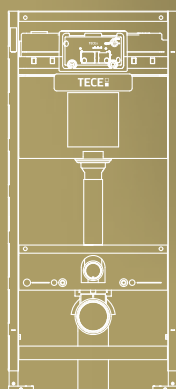

Everything begins with the support frame: the structural and design basis for every pre-wall construction.

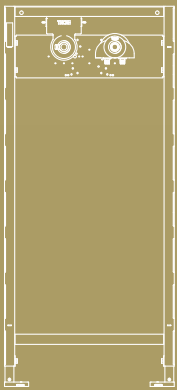

Bath/shower modules
for flush-mounted or
wall-mounted fittings.

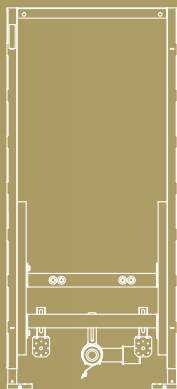

Bidet modules in different
installation heights.

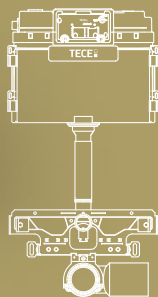

Connection units for
toilet, washstand or urinal,
without module frame for
direct assembly in the
TECEprofil support frame

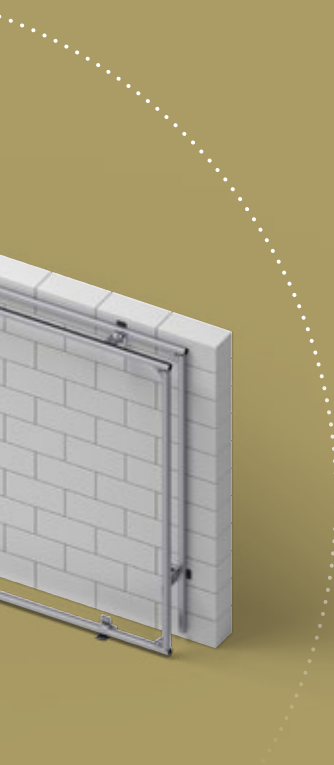

Certainty for every project. From small to large.

TECEprofil offers you reliability and flexibility in the system. The numerous applications range from the typical part-height pre-wall with toilet and washstand to free-standing walls to dividing walls with fittings on both sides.



CONTENTS

04	Freedom of design
06	More design freedom
10	New possibilities in bathroom design
12	Sanitary systems in commercial and public applications
14	TECEprofil – the pre-wall system
16	Basic components
18	Large heights and installation distances
20	Sanitary modules
22	Practical example
24	Special components
26	Support frame cladding
28	Individual assembly and prefabrication
30	TECEsmartwall: The configurator for greater efficiency
32	Benefits of the planning software
34	Working with TECEsmartwall
36	Special cases
38	TECEprofil fulfils customers' wishes. And standards
40	Fire protection, sound insulation, statics

CREATIVE TO DESIGN, SIMPLE TO BUILD.

FREEDOM OF DESIGN.

Delight in maximum flexibility when designing your bathroom!
Whether in a new build or a renovated property.

The universal solution: Pre-wall technology with TECEprofil.

Architects, planners and fitters never find optimal conditions – neither in renovation projects nor in new builds. Sometimes the risers and downpipes are located too far away from the fixtures, sometimes the customer wants an optimised room layout in functional areas, sometimes sloping ceilings, dormers or unusual layouts complicate the process.

TECEprofil solves these tasks before they become a problem. You have total freedom of design and the ability to realise everything simply, safely, quickly and cleanly. Creatively implement different functional arrangements in the space available or integrate storage areas into the fittings. Planning everything with the customer is just as easy as prefabrication in the fitter's workshop or on an industrial basis by TECE. Everyone involved in the project will agree: Pre-wall with TECEprofil is THE solution.



MORE POSSIBILITIES. THROUGH PIPES IN THE PRE-WALL.

TECEprofil lets you position the bathroom furniture wherever you like. Because the pre-wall technology allows you to run the pipes inside the pre-wall. Use the extensive design freedom for your customers.

Old pipes, old problems.

Chamfering for the downpipe



All supply pipes were mortised into the wall. That weakens the wall's structure and frequently leads to sound bridges.

Base for the drain line of the bathtub, washstand and toilet

“In the past, the toilet with the 100 mm drain always had to be located where the down-pipe was. The smaller drain lines from the washstand and shower were then simply mortised in along the wall or boxed in. That was the end of the design possibilities.”



New pre-wall, new flexibility.

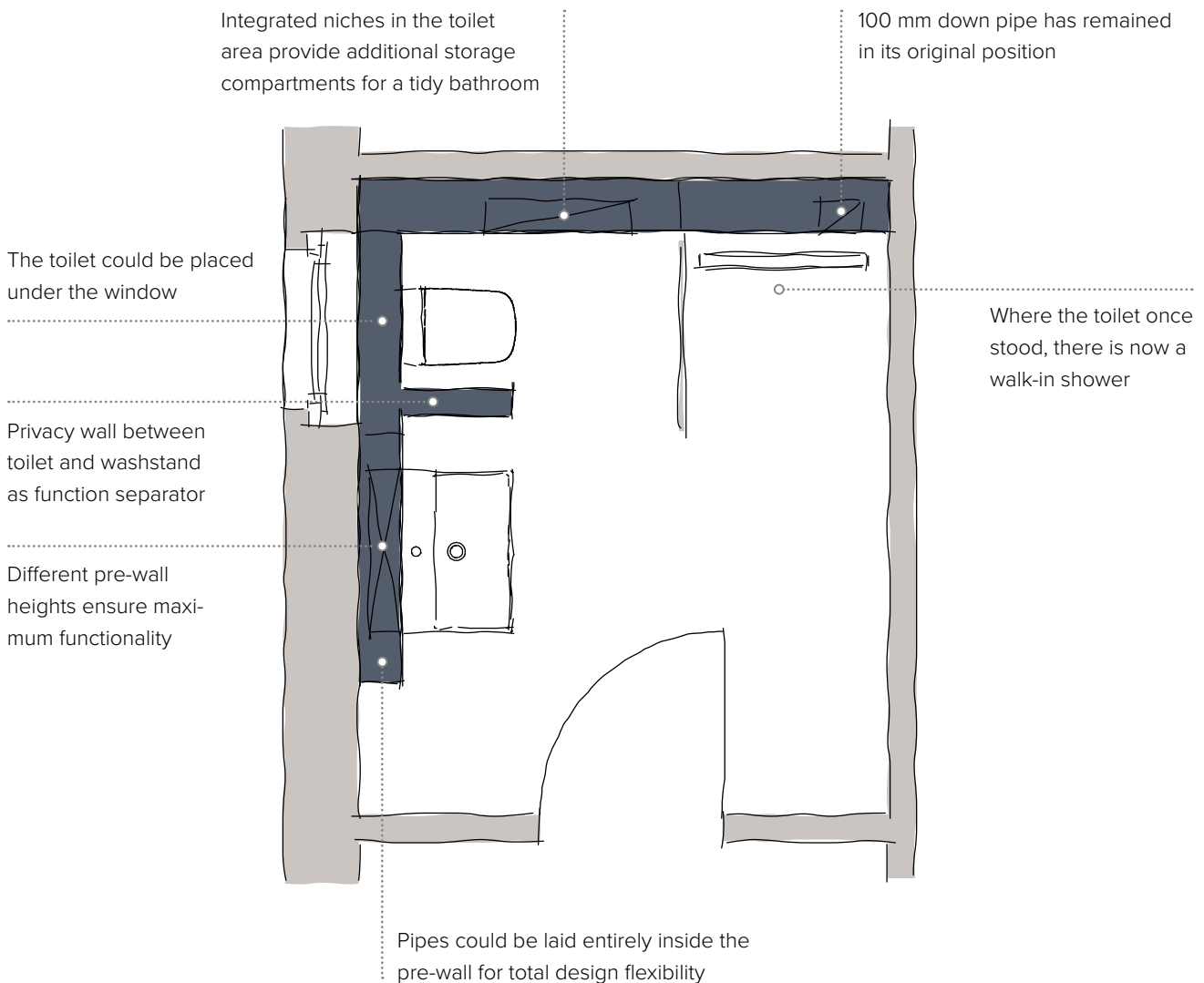

FREEDOM OF DESIGN

MORE POSSIBILITIES. MORE DESIGN FREEDOM.





Completely different, thanks to pre-wall installation:

Not only do the room-height pre-walls offer space to run the pipes and for a functional room layout but niches can also be easily integrated for a mirror cabinet and stylish shelving. The standard bathroom therefore becomes an impressive one of a kind.

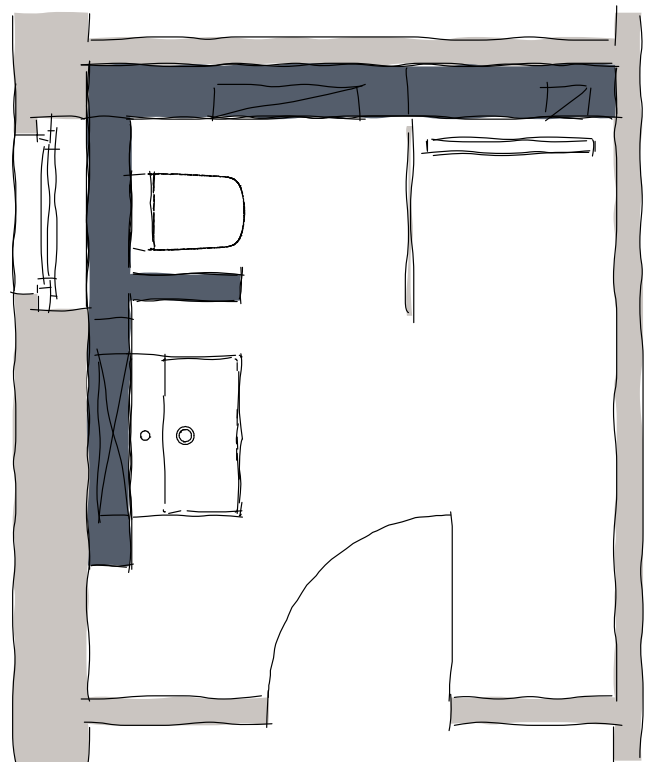

A FRESH LOOK AT BATHROOMS: ROOM FOR CREATIVITY.

It's not the floor plan that makes the bathroom,
it's what you make of it with TECEprofil.

TECEprofil is a flexible, stable and simple system for creative room design and the simple integration of building service applications – a functional modular system that enables you to make optimum use of even small bathrooms. Once the positioning of the pipes is no longer the limiting factor, bathrooms of any size can be given a fresh look.

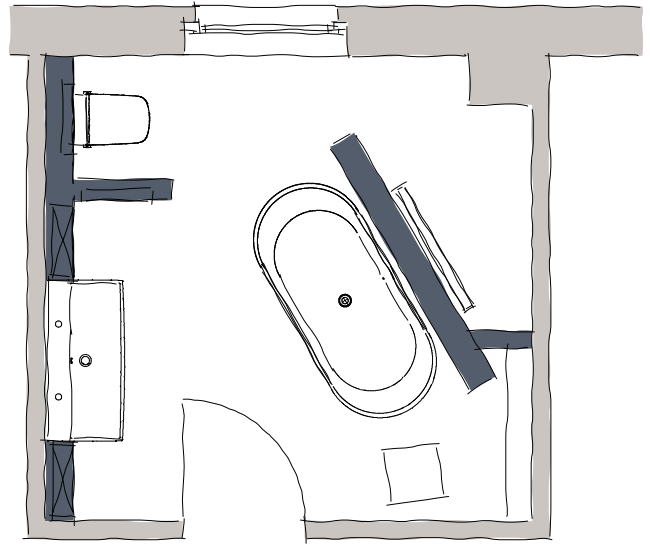

Designing freedom

- **Practical:** Storage compartments, shelves or strip lighting can be integrated in advance
- **Creative:** Division into functional areas can be easily realised
- **Invisible:** The technology remains hidden; function and living space come to the fore
- **Versatile:** One floor plan, many possibilities: The technology follows the creativity
- **Future-proof:** For example, a shower toilet can be easily retrofitted at a later date with TECElux
- **Variable:** In front of a solid wall or dry-wall construction, free-standing, part- or room-height, only as shaft cladding or with the sanitary wall as a partition wall: Everything is possible

Toilet as divider

- Room-height sanitary wall at the toilet creates space for built-in cabinets or washing machine and dryer
- Bathtub and shower separated by 2 m-high pre-wall
- Shower fitting in partition wall between shower and bathtub
- Generous feeling of space through walk-in shower with high-quality shower channel and glass splash guard
- Mirror cabinet integrated flush-mounted into room-height pre-wall

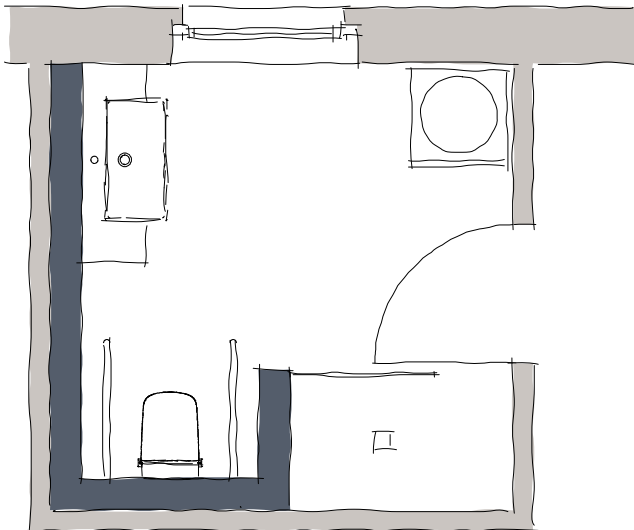
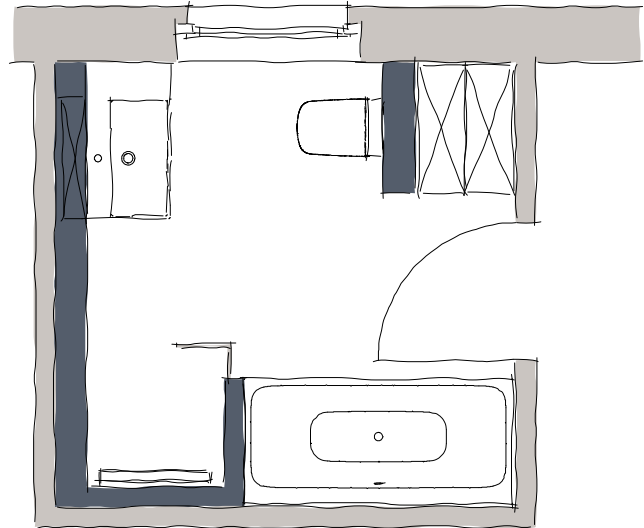

Prepared for shower toilet

- Wheelchair-accessible washstand supports the generous sense of space
- Equipped for shower toilet; simple through modern installation elements
- Point drain with tileable channel in the shower for optimal drainage
- Shower fitting integrated into the partition wall

Bench in shower area

- Clear division of functions with pre-wall as partition to the shower area
- Partition wall to shower additionally with washstand
- Niches in the pre-wall create order
- Walk-in shower with bench separated by part-height pre-wall; no further shower partitions necessary
- Storage compartments and illuminated niches create accents

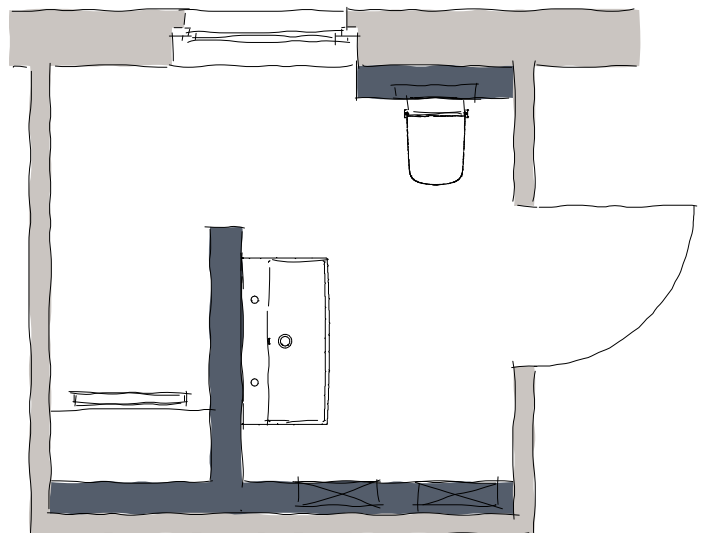

PUBLIC, SEMI-PUBLIC: AS LONG AS IT'S TECEprofil.

Private bathrooms aren't the only areas you'll be able to design functionally and creatively with a pre-wall. You can also benefit from the pre-wall technology in commercial and public areas. For example, when installing sanitary facilities in restaurants or offices.

Integrated accessories

Paper and soap dispensers or wooden panels can be installed as reinforced attachment points in the room-height sanitary wall with connection units for washstands.

Sturdy support

The Geronto toilet module is installed in a 1.20 m part-height pre-wall in front of a solid wall. The safety support arms are attached to special steel plates on the module.

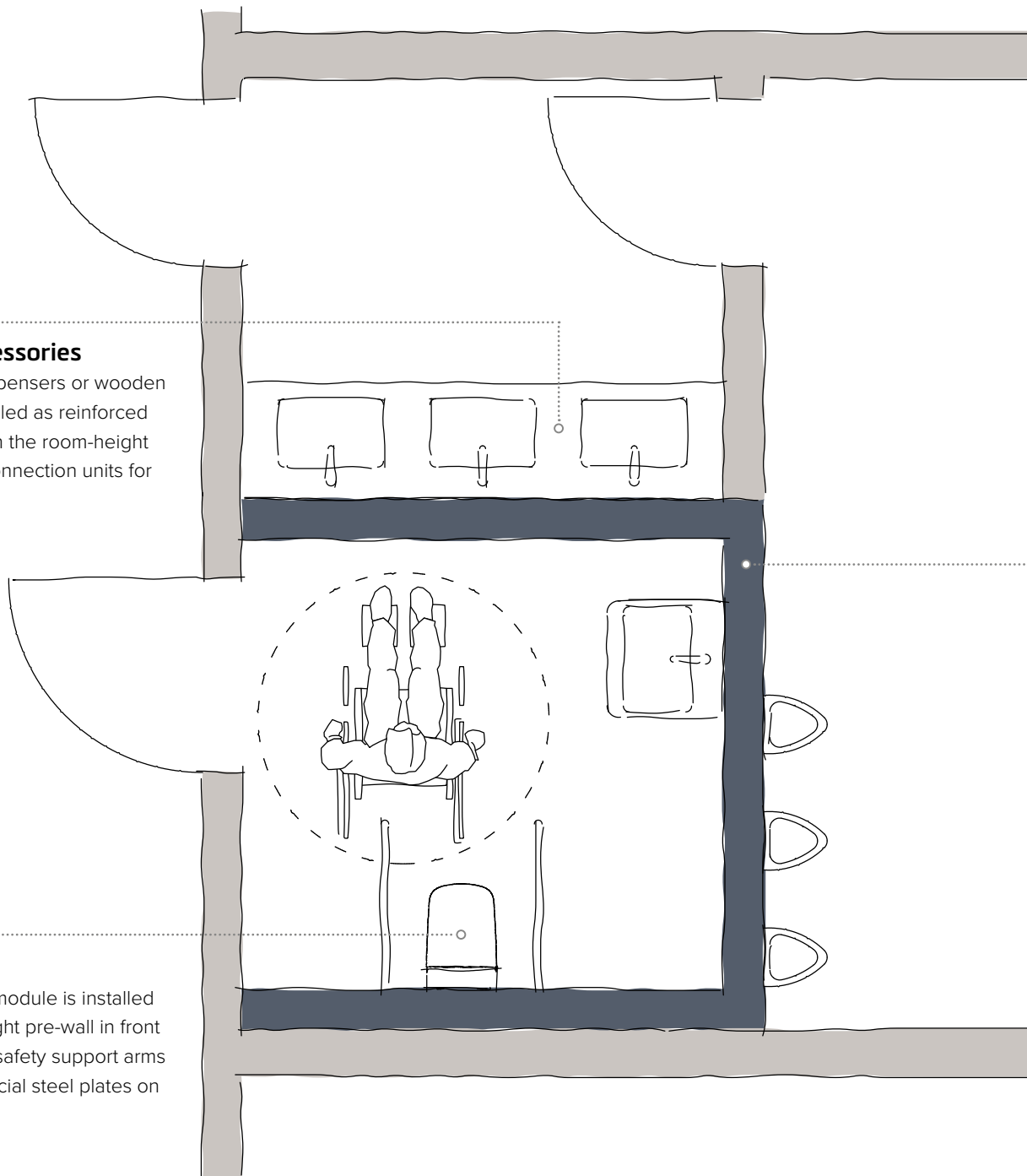

More space, more flexibility

The room-height sanitary walls for the installation technology create a separate space. Fan housings and air extraction pipes can be simply housed inside the sanitary wall. The washstand module with flush-mounted odour trap enables the installation of an wheelchair-accessible washstand.

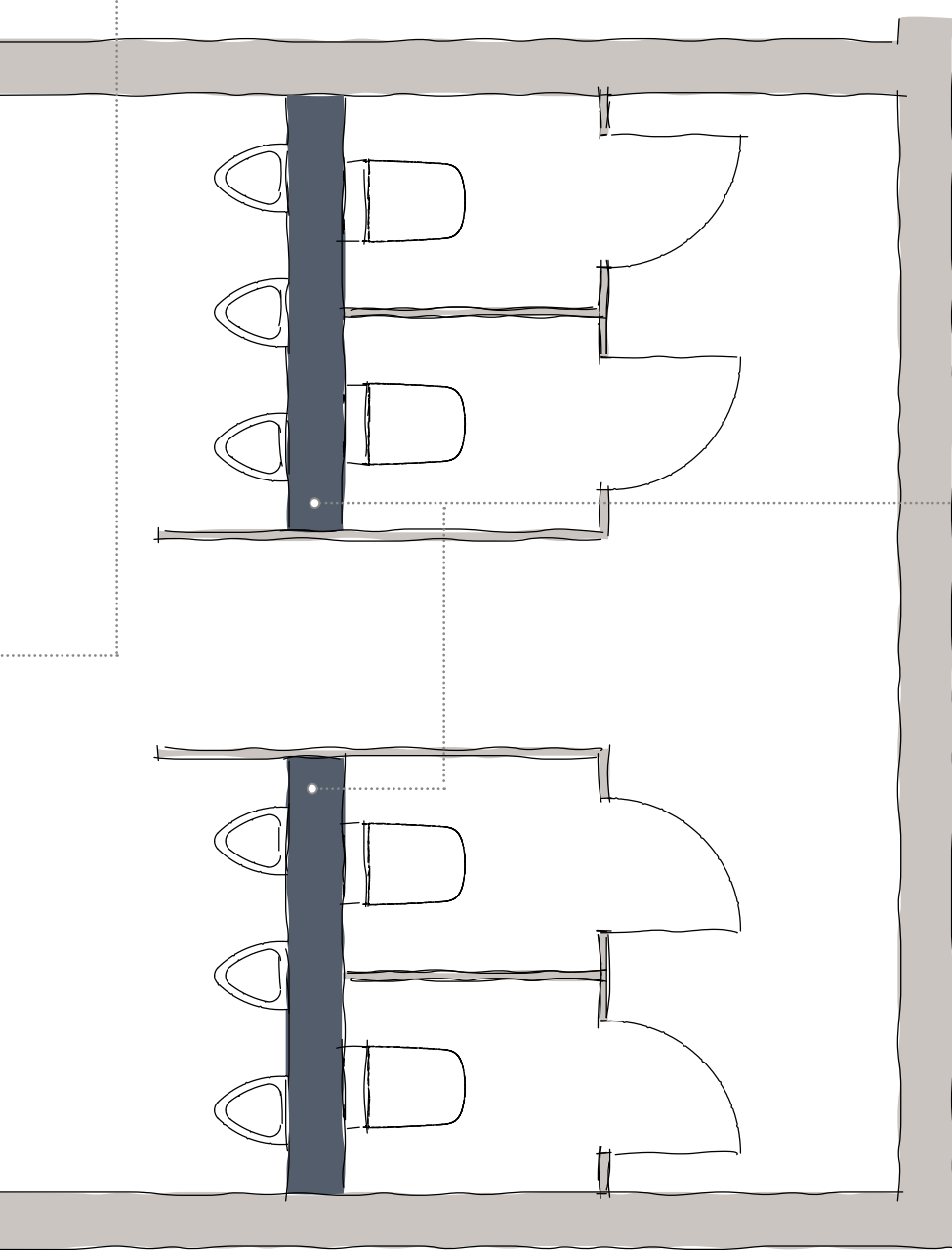

Clearly defined functional areas

The space is divided clearly into functional areas through the installation of two sanitary walls. The walls are designed only part-height at 2.10 m tall to make the room appear more spacious. The sanitary modules are also attached to both sides of the sanitary walls.

CREATIVE TO DESIGN, SIMPLE TO BUILD.

TECEprofil – THE PRE-WALL SYSTEM.

The simple solution for complex tasks.

What does a pre-wall system have to be able to do from the fitter's perspective?

As a fitter, you'd like to be able to plan and assemble particularly simply with a pre-wall system. Everything has to function reliably in an easy-to-understand way. You should be able to implement your creative ideas in a technically simple manner to suit your plans. Of course, you also want to be sure that the system is structurally resilient and that the requirements for sound insulation and fire protection standards are met.



THREE COMPONENTS, ALL POSSIBILITIES.

You want to fulfil your customer's wishes, design your everyday construction site activities and storage facilities as efficiently as possible, master technical challenges, assemble everything effortlessly and safely, comply with normative basics and deliver a safe installation. That's a lot of requirements that we fulfil quite simply: with the basic components of TECEprofil.



TECEprofil corner joint

- Connection is always automatically aligned at right angles
- Simplified assembly through pre-tensioned compression springs
- No die casting or plastic, but entirely sheet metal: also resistant in a fire



TECEprofil angle bracket

- Height- and depth-adjustable
- Accepts tolerances on the solid or dry-wall construction wall at all times



TECEprofil section tube

- Maximum spans and greater safety in a fire through the closed galvanised steel section and additional beading at the edges
- Excellent structural properties: robust, stable and torsionally rigid



Automatically rectangular

- Tolerances of up to 10 mm are easily compensated for
- Diagonally cut sections or incorrect dimensions can also be tolerated by several mm



Angle bracket in use

- Solid bracket for wall attachment
- Compensation of structural tolerances
- Very large adjustment range
- Sound-insulating rubber for sound insulation (accessory)



TALL, WIDE, SAFE. AND YET SO FLEXIBLE.

With TECEprofil, flexibility and stability supplement each other to form a unit.



Realise large heights and installation spacings

With the TECEprofil support frame, you can build as high or wide as required – but always safely. And in accordance with the simplest of design rules. Sanitary walls of up to 4500 mm in height are possible. As is attachment in front of a solid or dry-wall construction wall – or entirely free-standing. Large installation spacings of up to 1200 mm are also no problem.

Standard wall

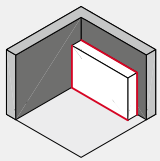

Standard wall, partial height and floor-to-ceiling height, with or without side attachment

Height: Standard 1150 mm, max. 4500 mm

Depth: min. 115 mm, max. 500 mm

Width: unlimited

Special wall

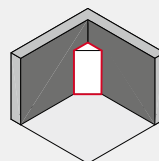

Partial height and room height corner construction 45° in front of a structural corner

Height: max. 4500 mm

Depth: min. 350 mm

Width: min. leg length 495 mm

19

Free-standing wall

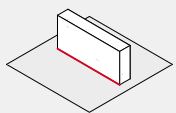

Free-standing, part-height sanitary wall

Height: Standard 1150 mm, max. 2100 mm

Depth: min. 210 mm

Width: max. 2400 mm

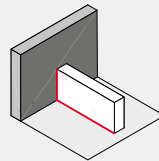

Part-height sanitary wall

Height: Standard 1150 mm, max. 2100 mm

Depth: min. 210 mm

Width: max. 2400 mm

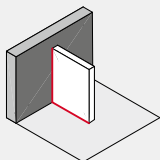

Part-height privacy wall

(only approved for integrated fittings)

Height: max. 2100 mm

Depth: min. 170 mm

Width: max. 1200 mm

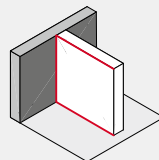

Room-height sanitary wall

Height: max. 4500 mm

Depth: min. 210 mm

Width: max. 2400 mm

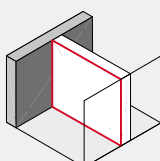

Room partition wall

Height: max. 4500 mm

Depth: min. 170 mm

Width: a vertical strut is required every 2400 mm on either side of the wall.

— Mounting level on structural shell

When planning and executing your design, please note the assembly guidelines in our Technical Information

SUPPORTING FRAME PLUS SANITARY MODULE: THE INSTALLATION WALL IS READY!

TECEprofil sanitary modules bring function to the support frame.

Our sanitary modules are completely pre-assembled and can be inserted into the support frame straight out of the box. Thus, e.g. in the TECEprofil toilet module, the cistern is sealed and only has to be opened during fine installation. That saves time and prevents dirt getting in during the building phase.

Insert, align, attach: With corner joints and locking mechanisms, the module and support frame can be connected to each other in an easy and stable way.

With this simple and diverse concept, a single fitter can create entire bathrooms with TECEprofil all the way through to tile-ready surfaces. With just a few components, infinite combination options and a large selection of pre-fabricated modules.



Foot brake

The module can be pulled out to the correct installation height with little force. The foot brake prevents slipping.



Placement

Placement of module feet on the lower profile brace.



Universality in the system

With the TECEprofil for sanitary modules, you always have the choice between universal or special solutions. This means you can easily upgrade the universal TECEprofil toilet module for special applications, too, without a problem. With the right accessory, the universal toilet module then becomes, for example, a toilet module with odour extraction. However, if you have to install several toilets with odour extraction, it is worthwhile using a special module with this function.

Wide range of uses

TECEprofil offers modules for almost all requirements in the sanitary sector: Toilet modules for nurseries, Geronto toilet modules, urinal modules for installation in rows and much more besides.

Here is a selection of our most popular models:



Attachment

The modules are attached to the support frame with corner joints via the slotted sections in the module frame.



Locking

After the module feet have been locked, the module is permanently connected with the lower continuous section brace.

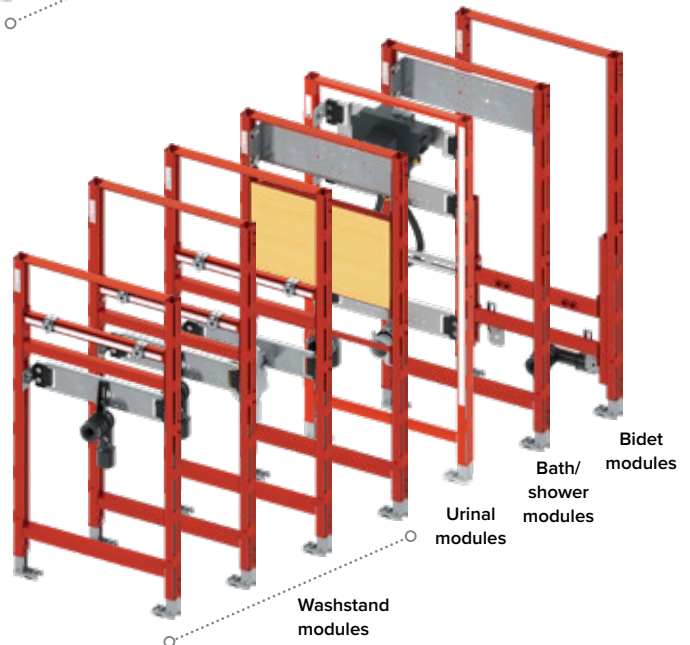
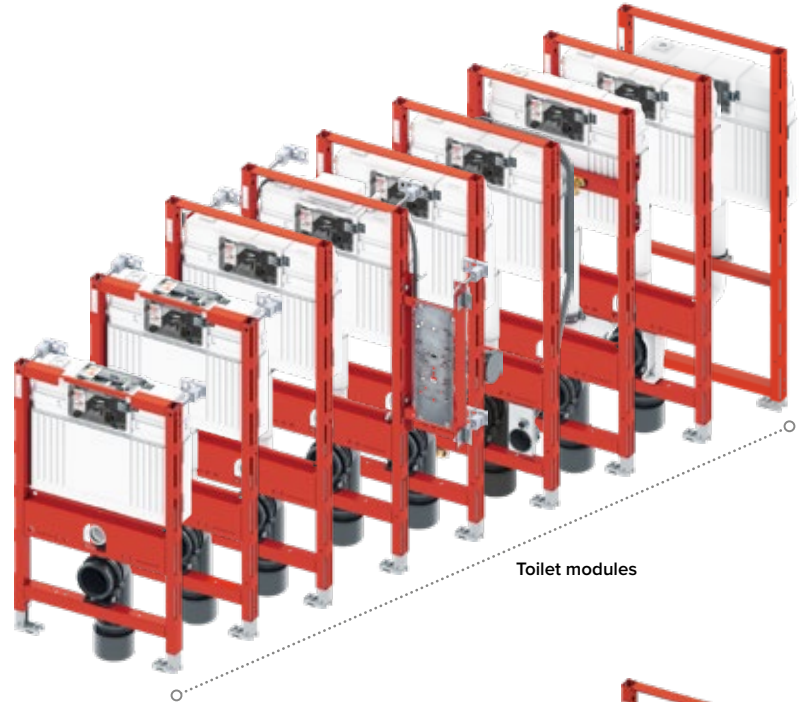

You can find more information and details in our product database.

TECEprofil IN PRACTICE: WAYS TO WORK.

The left-hand TECEprofil installation wall in detail:



Quiet, please!

All components in the TECEprofil system are sound-insulated.



Ready to use

Out of the box, into the wall: The TECEprofil toilet module is completely pre-assembled and sealed.



Practical

The connection unit for the washing machine with wall-mounted siphon hides itself away discreetly on the front of the pre-wall.



Jostling allowed

The TECEprofil supporting foot gives the free-standing wall the required stability. So even if it is accidentally knocked, it remains torsionally rigid and the tiles are not damaged.

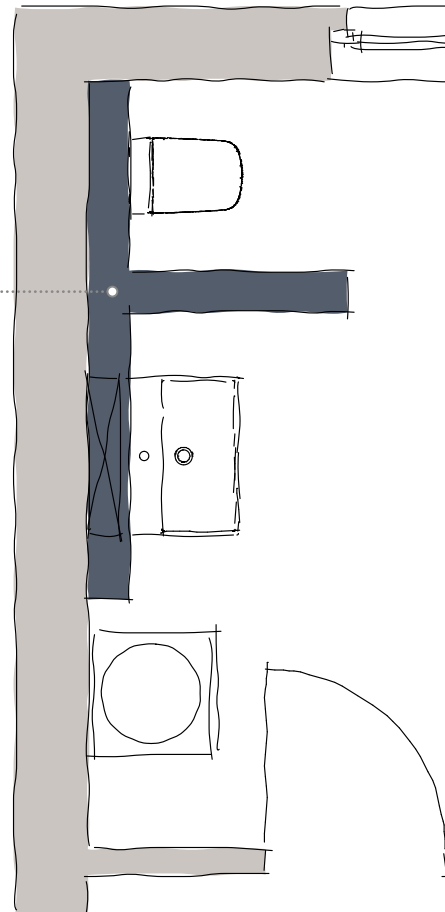

The right-hand TECEprofil installation wall in detail:



Tub support made from TECEprofil

Whether for acrylic or steel bathtub: You can create stable and load-bearing tub supports in an instant with TECEprofil. Matching caps made from hard rubber provide a good support.

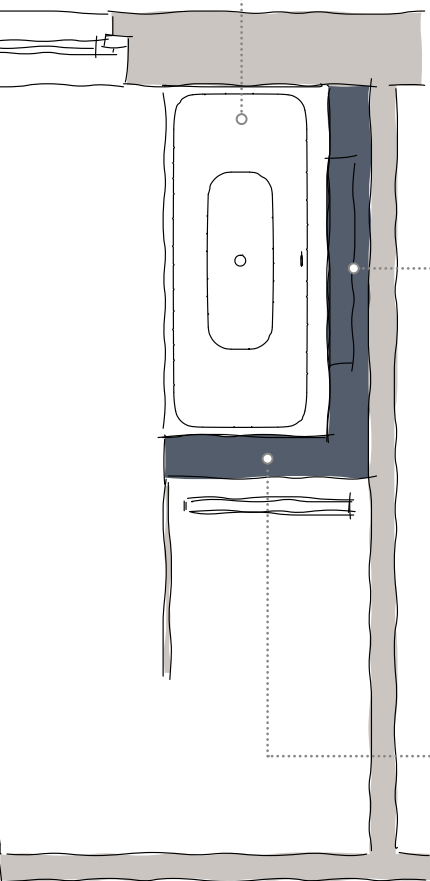

Diagonally, if you like

With TECEprofil, pre-walls can also be created at any angle under sloping ceilings. Also on trend are niches in the pre-wall – built in a few steps with TECEprofil.



Walk-in!

The room-height TECEprofil wall forms the crowning glory of the bathtub pre-wall and, at the same time, creates the space for a walk-in shower. The TECEprofil attachment plate at the bottom left of the image serves to safely attach the tub anchor.

FOR DIFFICULT TASKS: CLEVER SPECIAL PARTS.

For the special attachment of pipes, dealing with sloping ceilings or for saving materials: The special components of TECEprofil simplify the work even further and are a useful addition to the system. This makes it possible realise almost every structural requirement in the bathroom.



Double joint

For the simultaneous attachment of two TECEprofil section tubes (without intermediate bars) on the structural shell, e.g. for half-height pre-walls.



Foot for free-standing walls

To safely brace free-standing TECEprofil support frames.



Universal connector

It isn't always possible to work at right angles. To cope with this, use the infinitely adjustable universal connector for any angle.



Ball joint

For the universal attachment of components in the TECEprofil support frame. With the ball joint, it is possible to set any angle and position.



Fixing bracket

Available in M8 and M10 versions for mounting a threaded rod.



TECEprofil section tube connector

To create a stable axial connection between two TECEprofil section tubes.



TECEprofil plug-in foot

The height-adjustable foot has an end cap with rubber support. It is simply pushed into the section tube to ensure safe and even load bearing.



Attachment plate for additional fittings

The waterproof, glued wood inlay panel is suitable for the stable attachment of, for example, mirror cabinets and bathtub anchors.



SIMPLE TO THE END: CLADDING THE SUPPORT FRAME.

Plasterboard is not your favourite building material. But it is easy for you to work with: Cladding the support frame is effortless with the practical TECEprofil panel plates. The stable 18 mm-thick plasterboard panel in the handy size can be attached in a single layer. Try it for yourself!



After completing a pressure test and leak test, the pre-wall is ready for the panel facing.



To avoid panel joints/transitions in the area of the sanitary modules, the first whole panels should be assembled here.



The rest of the panel facing is then attached. Finally, the horizontal panel facing is put in place.

Easier than you'd think

The panel plates are very easy to work with. You'll be done in just a few steps:



Mark the holes for the panel facing of the toilet module using the template enclosed in every module box.



Drill the holes.



Mount the plasterboard panels using self-tapping screws.

1

TECEprofil wetroom panel

18 mm, made of German standard DIN 4102-A2 impregnated plasterboard, non-flammable. 1350 x 625 x 18 mm

2

TECEprofil panel plate

for extremely wet areas, 12.5 mm thick cement-bound lightweight concrete panel, in accordance with DIN EN 13501-1, non-flammable. 1350 x 625 x 12.5 mm



1

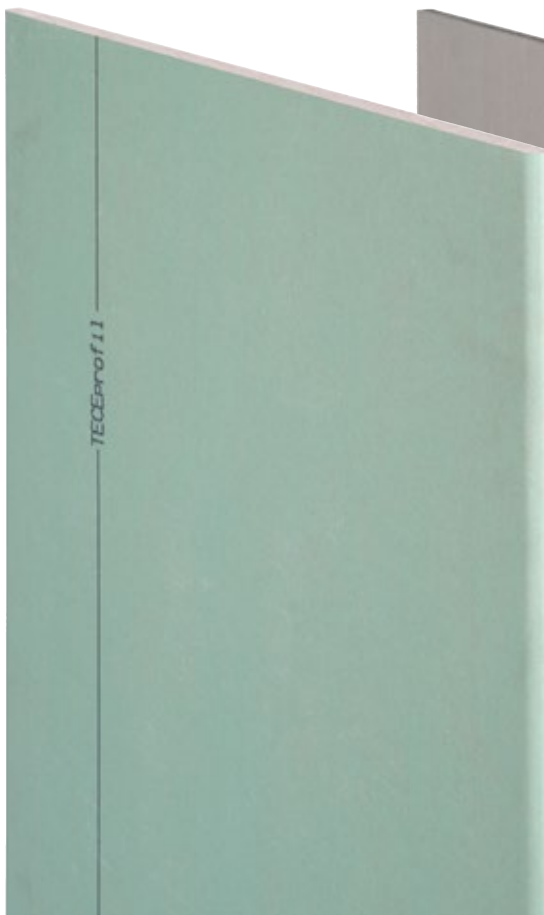

2



ALWAYS WELL INSTALLED: FROM INDIVIDUAL TO INDUSTRIAL.

TECEprofil is the system for every size of building. From individual use on site to industrial prefabrication in the building, TECEprofil accompanies you on every construction site. Moreover, the basic components and the assembly principle are always the same. That creates confidence and simplifies the work.

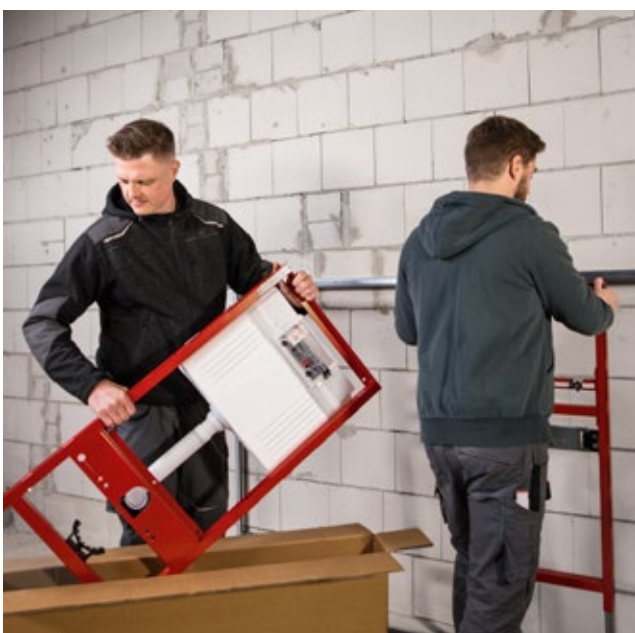

Individually on site

Unload the materials and then simply create the sanitary wall on site piece by piece without lots of pre-planning. That is certainly the most frequent type of assembly for “single items”. A system comprising of a small number of basic components and easy-to-understand assembly principles simplifies work on the construction site.



In-house prefabrication

Right on trend is the efficient prefabrication of TECEprofil sanitary walls in your own workshop. This avoids you having to unpack and put away materials and tools every day. Long tooling and journey times are a thing of the past. Pre-planning delivers lists of materials and cutting schedules; all necessary components are considered. The planning software also avoids errors or deviations from the assembly guidelines. Statics and sound insulation have been systematically considered. Even plumbing the pre-walls with potable water and drain lines can be completed in the workshop. The finished wall then only has to be set up on site and fixed to the structural shell.

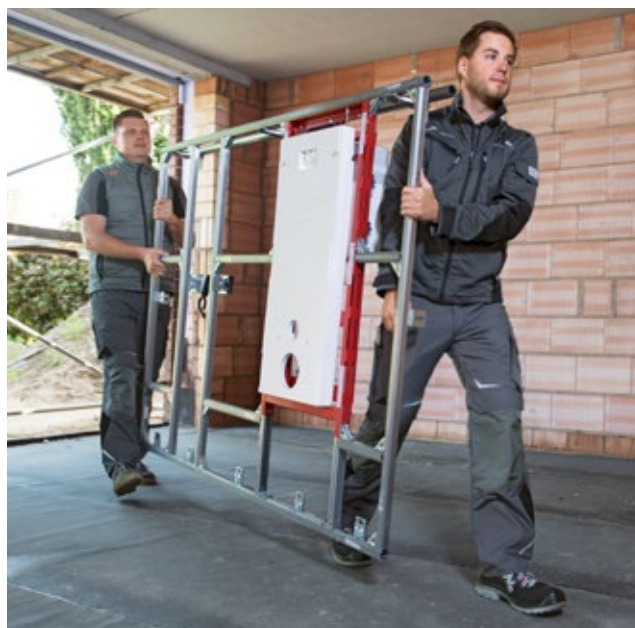



Industrial prefabrication

On large projects, you get the greatest possible planning certainty through industrial prefabrication of the sanitary walls at TECE. With TECESystem, deadlines are fixed from the start, fewer trades conflict with one another and the risk of construction delays is minimised.



You can find more information about TECESystem on our website.

CREATIVE TO DESIGN, SIMPLE TO BUILD.

TECEsmartwall: THE CONFIGURATOR FOR GREATER EFFICIENCY.

The convenient online tool.

Planning in the office, prefabrication in the workshop: the better solution.

A construction site is not always the best place for storing items or efficient workflows. The materials and assembly site are often in different places. With longer journey times that put a drag on value-generating productivity. Therefore, prefabricating assemblies in the workshop is usually the more cost-effective solution. Shorter journeys, a better material supply and much shorter tooling times make prefabrication in the workshop the smart alternative for professionals. Even more so with a well thought out planning tool.



FAST, EASY, ERROR-FREE: THAT'S HOW YOU PLAN NOWADAYS.

With the new TECEsmartwall configurator, you can now plan your TECEprofil installation walls even better. The program is easy and intuitive to use. In just a few steps, you'll create invitations to tender, offers, detail lists and a precise calculation.

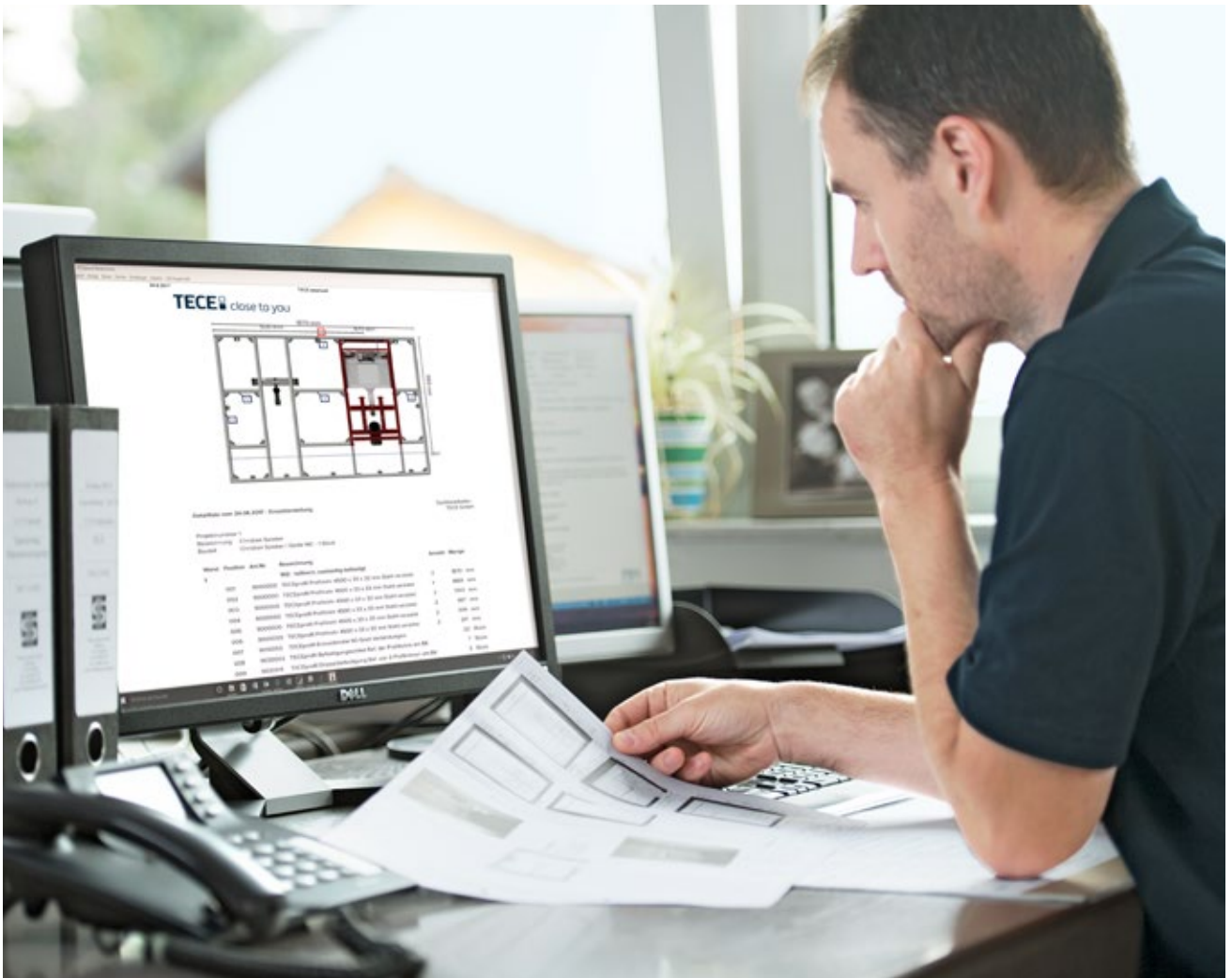

TECEprofil bathroom planning with TECEsmartwall

The TECEsmartwall software is the tool for planning and calculating TECEprofil pre-walls. The easy-to-use program unlocks all the advantages of the TECEprofil system for you.

With TECEprofil, the bathroom remains the fitter's trade, from planning through to the ready-to-tile surface. The planning of individual private bathrooms is just as easy as prefabricating multiple units in the workshop – this is particularly worthwhile for renovations of occupied buildings.

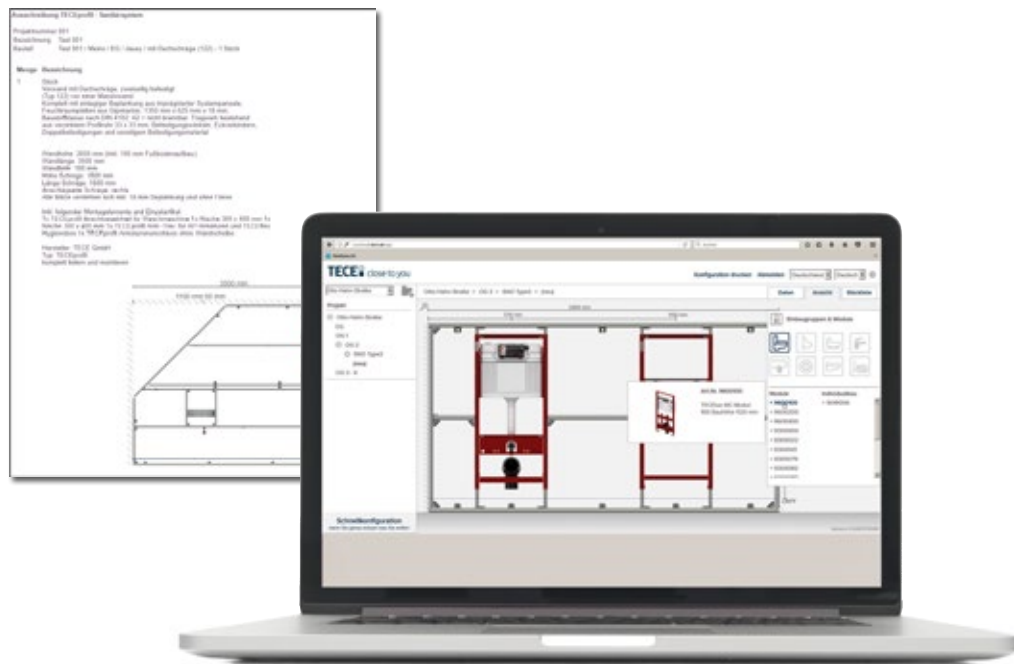

And this is how easy it is:

Step 1:

Go to smartwall.tece.de on the internet and register just once! For free of course! You should preferably invest in your customer service, rather than spend money on software.

Step 2:

Create your project and the associated walls.

Step 3:

For each wall, you will be automatically asked for the dimensions. So that nothing can be forgotten.

Step 4:

Place the sanitary modules, connection units or the desired niches in your sanitary wall. Done!

Program features

- Permanently available as an online tool
- Also compatible with mobile devices
- Products of the current assortment list
- Fast construction of installation walls
- Optional tender and offer document generation
- Preparation of dimensioned wall sketches
- GAEB file
- Creation of detail, material and calculation lists
- No update or service costs



More information at:
tece.com/en/service/software/tecesmartwall



ONLINE WELL THOUGHT OUT. MANUFACTURED IN THE WORKSHOP.

Straightforward assembly in well-known surroundings.

The tasks

- Would your customer like as little dirt and noise as possible during the upcoming bathroom renovation?
- Is there no space in the house to cut the section rails?
- The bathroom renovation is on the 4th floor and you don't want to have to run to the garage for each length of profile?
- Do you have several identical or similar pre-wall situations?
- Do you work on the construction site alongside bricklayers, plasterers, electricians and tilers? Where do you put your materials?

The simple solution

Prefabrication of the desired installation wall in your workshop and delivery to the construction site ready to go! Thanks to optimal software support, nothing is forgotten.

You don't need any additional components such as transport locks or bracing angles for transport to the construction site.

You only need one day for the complete installation of the pre-wall including piping and panel facing. To the delight of your customers!

Working with TECEsmartwall in detail:

Step 1: Dimensioning on the construction site

Take down the dimensions on site, no matter whether refurbishment, renovation or new build. Whether for 1, 2 or 50 pre-walls.



Step 2: Planning with TECEsmartwall

TECEsmartwall supports you easily, quickly and reliably. Free of charge and available online at all times.



Step 3: Prefabrication in the workshop

TECEsmartwall not only lets you design your pre-wall quickly and easily but also lets you prepare the parts list, all with millimetre precision and with all necessary components. For certainty during implementation!

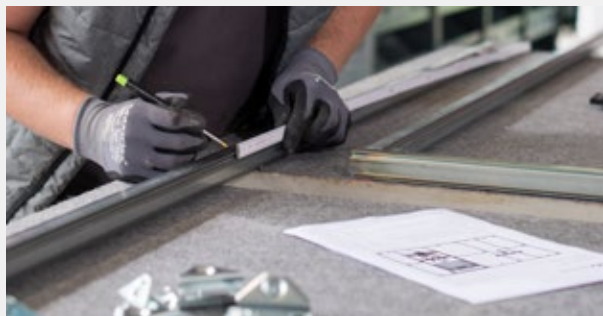

Step 4: Delivery to the construction site

The finished installation wall is brought to the construction site; with the necessary mounting materials, of course.



Step 5: Assembled pre-wall

Attachment points are quickly marked, holes drilled and the pre-wall screwed into place. Ready to plank and tile!



REALLY SMART. SIMPLY EFFICIENT.

Whether free-standing walls, sloping ceilings, integrated niches or walls used on both sides: TECEsmartwall gives space to creative ideas.

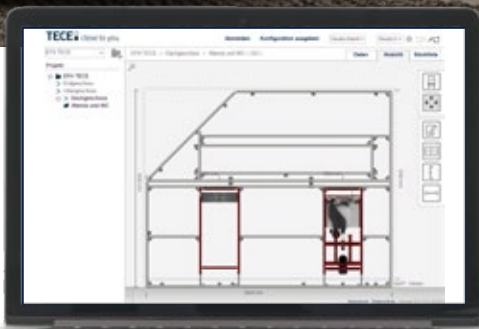

Inclined style

The bathtub placed under the sloping ceiling, a spacious niche placed directly above it and the toilet with odour extraction set into the same pre-wall: Planned with TECEsmartwall, built with TECEprofil. Inclined. Fast. Smart.



Always in sequence

A part-height installation wall, many identical sanitary objects, less time to plan: That's what reality often looks like on large construction sites. With TECEsmartwall and TECEprofil, you can also carry out such tasks effectively and with reliable planning. The system limits are controlled by TECEsmartwall, so that you can concentrate on the overall planning.



A difficult task simply solved

The combination of TECEsmartwall, the TECEprofil Geronto module and the TECEprofil washstand module with flush-mounted odour trap guarantees the rapid planning and realisation of a barrier-free sanitary area.

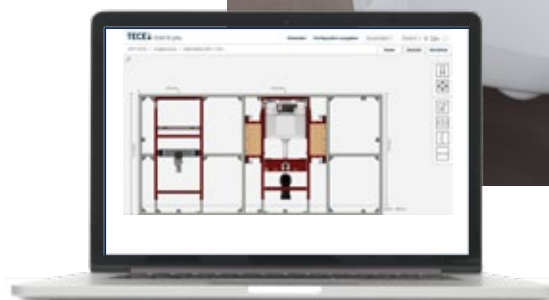

CLEVER IN THE DETAILS, SAFE AS A WHOLE

TECEprofil FULFILLS CUSTOMER REQUIREMENTS. AND STANDARDS.

Offering added value.

Simple, quick, clean, safe.

Sound insulation and fire protection, statics and, last but not least, potable water hygiene form the basis for the safe operation of a property. This is where the smart pre-wall system TECEprofil shows its full potential, because it has to fulfil all these requirements at once.



FIRE PROTECTION, SOUND INSULATION, STATICS: CONFIRMED EVERY TIME.

The performance of TECE products is constantly verified in the laboratory, in order to convince in practice.



Fire protection

The TECEprofil standard components can be used to create non-load-bearing, room-enclosing partition walls for fire protection requirements F30 to F120. The respective requirements are decisive for the layer thickness of the mineral wool insulation and the permitted fixtures.

- 1 Fire protection test at the MPA and iMBM of TU Braunschweig
- 2 Sound insulation test at the Fraunhofer Institute for Building Physics
- 3 Statics test at the MPA and iMBM of TU Braunschweig

2

Sound insulation

As with fire protection, sound insulation also comes down to the way all the components interact. Here, too, the TECEprofil system forms the basis for reducing the transmission of structure-borne and airborne sounds. In a series of sound insulation tests in front of solid and dry-wall construction walls, we have also qualified our system solutions for increased sound insulation requirements.



3

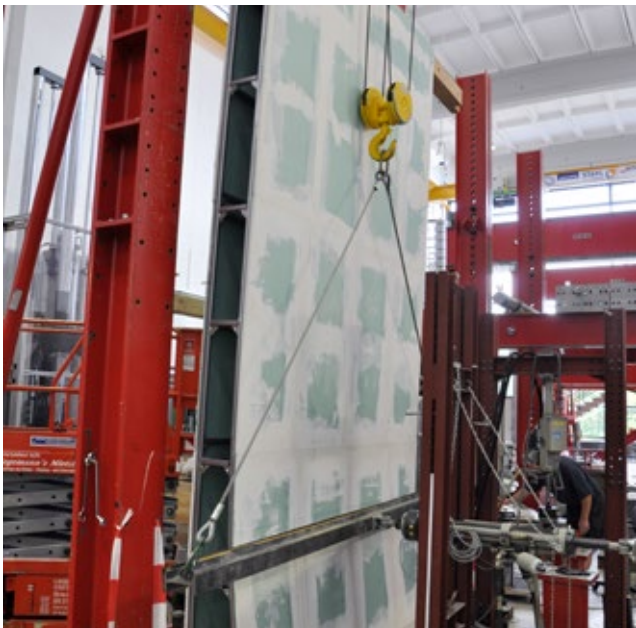

Statics

The various statics tests not only determine the maximum flexing of a 4.5 metre-high installation wall but also whether the TECEprofil support frame is able to take mandatory weights of 150 kg on the washstand or 400 kg on the middle of the toilet ceramics. A successful statics test is also an important prerequisite for fire protection.

The perfect solution for your project

Sound insulation and fire protection solutions are rarely available off the peg. Our application engineers therefore work with you to develop the best economic and technical solution for your project on the basis of the individual requirements.

We've been offering this service for more than 20 years. Again and again, we see that the earlier the participants agree, the better the results. For this reason, you should ideally get in touch with us at the start of the project.

GET TO KNOW US BETTER.

TECE provides expertise in further areas of competence. Visit www.tece.com, where you can find detailed information about the company, products and services.



Installation & Assembly

Straightforward, stress-free work. In this brochure, professional tradesmen can discover more about well-thought-out products, quality, services and the TECE Academy.



Design & Creation

Freedom of design. The themes of Space & Architecture, Individuality & Design and Function & Technology are aimed primarily at architects and bathroom planners.



Project & Planning

Reliability in terms of time, legal aspects and economic efficiency. This brochure is intended for planners, architects and investors.

